



PROFIL

MAK TRADE GROUP je kompanija koja se bavi proizvodnjom i prodajom artikala iz oblasti automatike, elektroinstalacionog materijala i elektro galanterije, rasvetnih tela i pribora, ventilacionih uređaja i dodatne opreme, grejnih tela, rezervnih delova bele tehnike.

Naši partneri, kupci i poverenje koje nam ukazuju olakšavaju naš napredak. Negujemo kuturu ponašanja koja podrazumeva da kroz komunikaciju saznamo šta je zaista važno uz visok stepen razumevanja i strpljenja. Radimo najbolje što možemo, osluškujemo potrebe, prilagođavamo se klijentima i trudimo se da budemo bolji. Naši klijenti su naš najveći izvor napretka. Insistiramo na kvalitetu i jako vodimo računa o zadovoljstvu korisnika naših proizvoda i usluga. Time gradimo poverenje i pouzdanost već punih 25 godina.

PROFILE

***MAK TRADE GROUP** is a company engaged in the production and sale of items in the field of automation, electrical installation material and electrical goods, lighting and accessories, fan units and additional equipment, heating devices and spare parts of household appliances.*

Our partners, customers and the trust they place in us make our progress easier. We nurture the culture of behaviour, which means that through communication we find out what is really important with a high degree of understanding and patience. We do the best we can, we listen to needs, we adapt to our clients and we strive to be better. Our clients are our biggest source of progress. We insist on quality and we take great care of the satisfaction of users of our products and services. With this, we have been building confidence and reliability for 25 years already.

MISIJA

Osnovni zadatak **MAK TRADE GROUP** je da proizvodi i distribuira kvalitetne i ekološke proizvode, obezbedi kvalitet života zaposlenih i zadovoljenje društvenih potreba. Svojom, što kvalitetnijom, ponudom proizvoda i usluga potrebno je stvoriti najbolje uslove za kupce.

Uz stručne i motivisane radnike pružiti što kvalitetniju uslugu, rastom i dinamičnim poslovanjem osigurati dobit za kompaniju.

Posredstvom naših akcija doprineti poboljšanju kvaliteta života u društvenom i prirodnom okruženju. Jednostavno, **MAK TRADE GROUP** treba da bude dobar i pouzdan partner svojim klijentima.

MISSION

*The main task of **MAK TRADE GROUP** is to produce and distribute quality and ecological products, ensure the quality of life of employees and satisfy social needs. With its offer of products and services being as high-quality as possible, it is necessary to create the best conditions for customers. With professional and motivated workers, provide as good a service as possible, with growth and dynamic business operations, ensure the profit for the company. Through our actions, we contribute to improving the quality of life in the social and natural environment. Simply, **MAK TRADE GROUP** should be a good and reliable partner to its clients.*



VIZIJA

Naša vizija je da budemo sinonim za kompaniju koja stalno postavlja više standarde kako u oblasti poslovanja, proizvodnje i trgovine, tako i u oblasti življenja i koja, ne samo da uvodi nove navike i trendove, nego ih i predviđa i kreira. Da budemo sinonim za kompaniju koja posluje u dosluhu s vremenom koje dolazi.

Od suštinske važnosti je održanje dinamičkog i stalnog razvoja koji će omogućiti kompaniji da drži korak sa konkurencijom, uz neophodnost stalnog, aktivnog praćenja i fleksibilnog prilagođavanja promenama u poslovnom okruženju.

VISION

Our vision is to be the synonym for a company which is constantly setting higher standards in business, production and trade, as well as in life and which not only introduces new habits and trends, but also anticipates and creates them. To be the synonym for a company which works in touch with the time to come.

It is essential to maintain a dynamic and continuous development which will enable the company to keep up with competition, with the need for a continuous, active monitoring and flexible adaptation to changes in the business environment.

CILJEVI / PLANOVI

Trudimo se da maksimalno ispunimo očekivanja, da klijentima obezbedimo kvalitet, vrednost, dobar izbor i uslugu i trudimo se da u tome budemo istrajni i dosledni.

Ciljevi **MAK TRADE GROUP** su:

- Povećanje udela proizvodnje u ukupnom poslovnim aktivnostima,
- Dugoročna saradnja sa našim kupcima/dobavljačima,
- Efikasniji način rada i smanjenje troškova ne zanemarujući kvalitet proizvoda,
- Širok asortiman visokokvalitetnih proizvoda po konkurentnim cenama,
- Podizanje logistike, usluga i komunikacije na još viši nivo.

Planovi za budućnost su jasni: osvajanje novih tehnologija, učvršćivanje dobrih odnosa sa partnerima i širenje tržišta, poštujući principe tržišnog poslovanja i trendove u modernom društvu.

Naš glavni poslovni cilj je osvajanje što više novih proizvoda, konkurentnih na domaćem ali i na tržištu u okruženju (zemlje ex YU), tržištu Ukrajine i Rusije, kao i na probirljivom tržištu EU.

GOALS / PLANS

We strive to maximally fulfill expectations, to provide our clients with quality, value, good choice and service and we strive to be persistent and consistent in doing so.

*The goals of **MAK TRADE GROUP** are:*

- *Increase in the share of production in total business activities,*
- *Long-term cooperation with our customers/suppliers,*
- *More efficient way of working and reducing costs without neglecting the quality of products,*
- *A wide range of high-quality products at competitive prices,*
- *Raising logistics, services and communication to an even higher level.*

Plans for the future are clear: conquering new technologies, fostering good relations with partners and expanding the market, while respecting the principles of market performance and trends in modern society.

Our main business goal is to conquer as many new products as possible, competitive in the domestic market as well as in the market of the surrounding countries (ex-YU countries), in the market of Ukraine and Russia, as well as in the selective EU market.

TIMSKI RAD

Verujemo da je ključ produktivnosti u zadovoljstvu zaposlenih. Mi smo tim različitih pojedinaca koje karakteriše slična motivacija i konstruktivan pristup prema drugim članovima tima. Zajedno ostvarujemo ciljeve koje je nemoguće ostvariti sam. Ponekada radimo na granicama svojih intelektualnih i fizičkih mogućnosti ali svaki naš rad biva nagrađen željenim znanjem. Cenimo znanje, iskustvo, veštinu i posvećenost naših zaposlenih i upravo je u tome naša snaga.

TEAM WORK

We believe that the key to productivity is the satisfaction of employees. We are a team of different individuals who are characterized by a similar motivation and a constructive approach towards other team members. Together, we achieve goals which are impossible to be achieved alone. Sometimes we work on the limits of our intellectual and physical capabilities, but each work of ours is rewarded with the desired knowledge. We appreciate knowledge, experience, skills and dedication of our employees and that is precisely our strength.

ISKRENOST I ODGOVORNOST

Smatramo da je u poslu kojim se bavimo iskrenost i transparentnost u poslovnim aktivnostima najbolji način da se zadobije poverenje klijenata.

To zahteva visoku posvećenost, prisiljava na ozbiljnost, traži ličnu odgovornost svih.

HONESTY AND RESPONSIBILITY

We believe that, in the business we are engaged in, honesty and transparency in business activities is the best way to gain the confidence of clients.

This requires high dedication, compels to seriousness, seeks personal responsibility of everyone.





KVALITET / STANDARDI / SERTIFIKATI



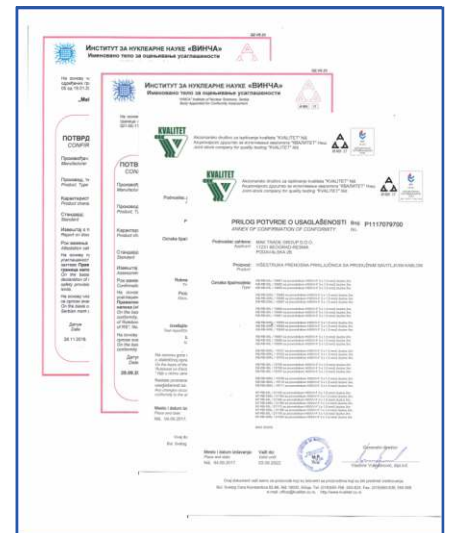













Vođeni idejom da je klijentu neophodno ponuditi proizvod visokog kvaliteta, **MAK TRADE GROUP**, već dugi niz godina posluje u skladu sa najvišim međunarodnim standardima, uspostavljenim menadžmentom kvaliteta ISO 9001:2008, kao i standardima ISO 14001:2005 i OHSAS 18001:2007. Proizvodi **MTG** i **M-T** brenda, zadovoljavaju visoke međunarodne standarde u pogledu kvaliteta i garancije, što dokazuju sertifikati slovenačkog instituta SIQ Ljubljana, kao i sertifikati i potvrde o usaglašenosti domaćih akreditovanih institucija. Naši najprodavaniji proizvodi poseduju potvrde o usaglašenosti i izjave za stavljanje CE oznaka, koje su neophodne da bi se našli na probirljivom tržištu EU. Kvalitet naših proizvoda je veoma cenjen, zahvaljujući dugoročnom i ulaganju u istraživanje i razvoj proizvoda, alata, primeni komponenti i materijala visokog kvaliteta, savremenih tehnologija i dopadljivog industrijskog dizajna.



QUALITY / STANDARDS / CERTIFICATES

Guided by the idea that a client needs to be offered a high quality product, **MAK TRADE GROUP** has been operating in accordance with the highest international standards, the established quality management ISO 9001: 2008, as well as ISO 14001: 2005 and OHSAS 18001: 2007 standards for many years. **MTG** and **M-T** brand products meet high international standards in terms of quality and guarantee, as evidenced by the certificates of Slovenian institute SIQ Ljubljana, as well as certifications and certificates of conformity of domestic accredited institutions. Our best-selling products have certificates of conformity and declarations for placement of CE marks, which are necessary in order for them to be found on the selective EU market. The quality of our products is highly appreciated, thanks to the long-term investment in research and development of products, tools, implementation of high quality components and materials, modern technologies and the appealing industrial design.



<p>KUPATILSKI VENTILATORI <i>BATHROOM FANS</i></p>	<p>5-36</p>		
<p>VIŠENAMENSKI VENTILATORI <i>MULTIFUNCTIONAL VENTILATORS</i></p>	<p>37-45</p>		
<p>VENTILACIONE REŠETKE ALUMINIJUMSKE <i>ALUMINIUM VENTILATION GRILLES</i></p>	<p>45-48</p>		
<p>VENTILATORI - PRATEĆA OPREMA <i>VENTILATOR ACCESSORIES</i></p>	<p>48-49</p>		
<p>PRIKLJUČNI KABLOVI <i>CONNECTION CABLES</i></p>	<p>51-56</p>		
<p>PRENOSNE PRIKLJUČNICE JEDNOSTRUKÉ <i>SINGLE PORTABLE SOCKETS-OUTLETS</i></p>	<p>58-62</p>		
<p>VIŠESTRUKÉ PRENOSNE PRIKLJUČNICE <i>MULTIPLE PORTABLE SOCKETS-OUTLETS</i></p>	<p>64-73</p>		
<p>KABLOVSKE MOTALICE <i>CABLE REELS</i></p>	<p>75-80</p>		
<p>PRENOSIVI GRAĐEVINSKI ORMANI <i>PORTABLE POWER DISTRIBUTION BOARDS</i></p>	<p>82-83</p>		
<p>KABLOVSKA SPOJNICA <i>CABLE CONNECTOR</i></p>	<p>84</p>		
<p>SABIRNICE <i>TERMINAL CONNECTORS</i></p>	<p>85-88</p>		
<p>RAZVODNE KUTIJE OG <i>JUNCTION BOX</i></p>	<p>89-90</p>		
<p>MOTORNA ZAŠTITNA SKLOPKA <i>MANUAL MOTOR PROTECTOR/STARTER</i></p>	<p>91-93</p>		
<p>ELEKTRIČNI KALORIFERI <i>FAN HEATERS - CALORIFERS</i></p>	<p>95-98</p>		
<p>GREJALICE KUPATILSKE <i>BATHROOM HEATERS</i></p>	<p>99</p>		
<p>KONFEKSIONIRANJE KABLOVA <i>CONFECTIONING OF CABLES</i></p>	<p>100</p>		

VENTILATORI I PRATEĆA OPREMA

VENTILATORS AND ACCESSORIES

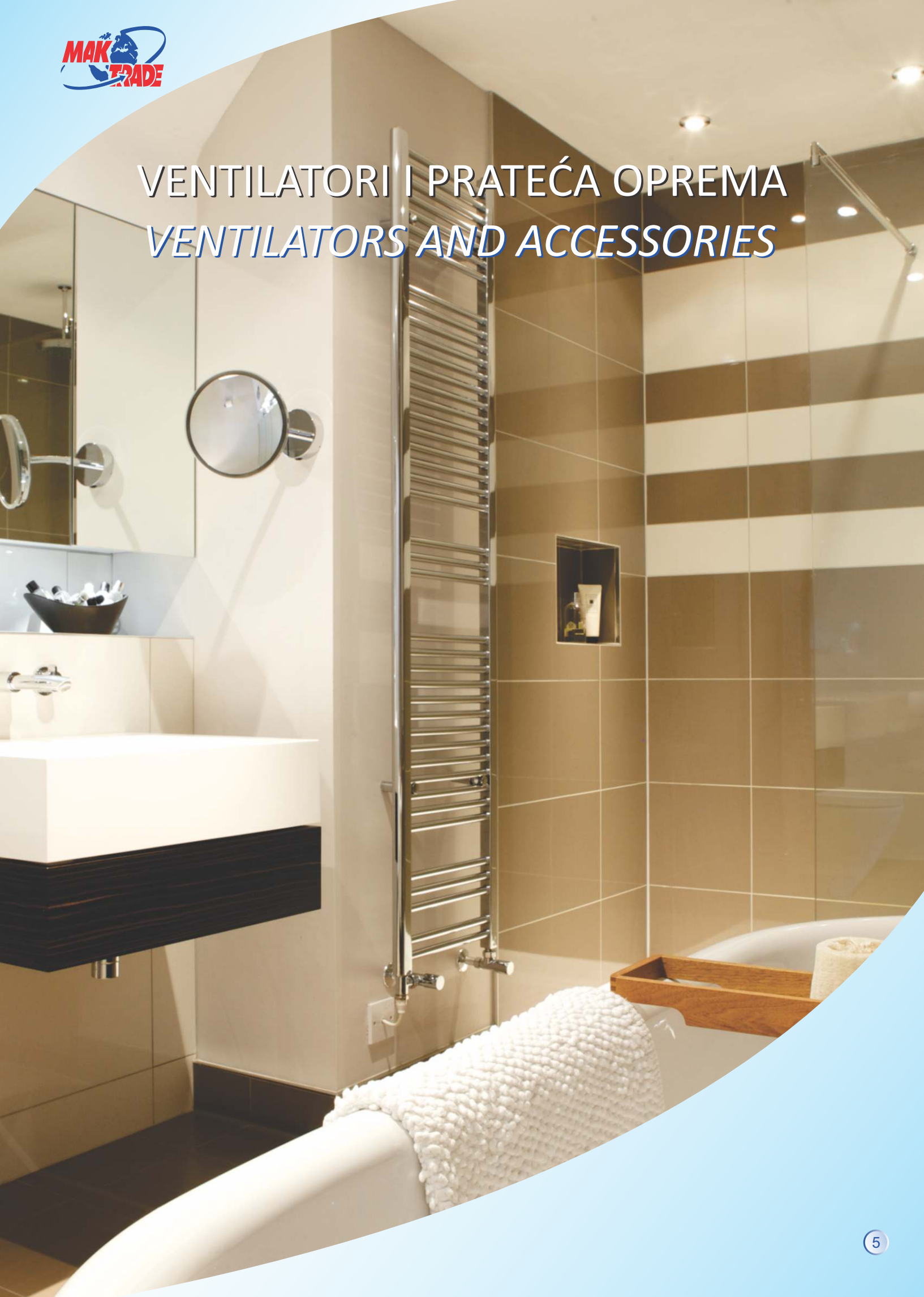

MTG A100XS / A120XS



A100XS / A120XS



Duže telo ventilatora,
žabice za laku montažu/
*Longer ventilator body,
hooks for easier mounting*



Veoma tihi /
Very silent



Lako skidanje panela /
Easy removable cover

GARANCIJA 5 GODINA
WARRANTY 5 YEARS

NAMENA VENTILATORA

Ventilatori su dizajnirani za ventilaciju stambenog ili poslovnog prostora. Upotrebljavaju se u prostorijama i na mestima gde je potrebno sprečiti širenje vlage i neprijatnih mirisa. Nisu namenjeni za upotrebu u radnim okruženjima i stambenim prostorijama gde temperatura vazduha prelazi 40°C. Ventilatori su vrlo lagani, poseduju moderan dizajn i odlikuju sa izuzetno tihim radom. Njihova ugradnja je vrlo jednostavna i brza. Telo ventilatora, maska i lopatice elise su izrađeni od kvalitetne plastike. Motor ventilatora opremljen je termičkom zaštitom (B klasa izolacije) koja sprečava dalji rad motora usled njegovog pregrevanja.

PURPOSE OF THE VENTILATOR

The ventilators are designed to ventilate housing or office space. They are used in premises and in places where spreading of humidity and odours needs to be prevented. They are not intended for use in work environments and housing facilities where air temperature exceeds 40°C. The ventilators are very light, with modern design and very silent operation. Its installation is very simple and quick. The ventilator body, mask and blades are made of quality plastic. The ventilator motor has a thermal equipment (insulation class B) which prevents motor overheating.

TEHNIČKE KARAKTERISTIKE:

Ventilator se priključuje na električnu mrežu (električnu struju) od 230V AC i frekvencije od 50Hz. Prema vrsti zaštite od strujnog udara, ventilator pripada uređajima klase II (230V / 50Hz). Ventilator je namenjen za eksploataciju na temperaturi vazduha u prostoriji u opsegu od +1°C do +40°C. Nivo buke na rastojanju od 3m ne prelazi 39dB(A).

TECHNICAL CHARACTERISTICS:

The ventilator is connected to electric power network (electric current) of AC voltage of 230V and 50Hz frequency. When it comes to electric shock protection, the ventilator belongs to Class II (230V / 50Hz). The ventilator is intended for exploitation in air temperatures in the range from +1°C to +40°C. Noise level on 3m distance does not exceed 39dB(A).

MODELI / MODELS:

T - TAJMER+KLAPNA / *TIMER+FLAP*
H - HIGRO-TAJMER+KLAPNA / *HYGROTIMER+FLAP*
K - KLAPNA / *FLAP*

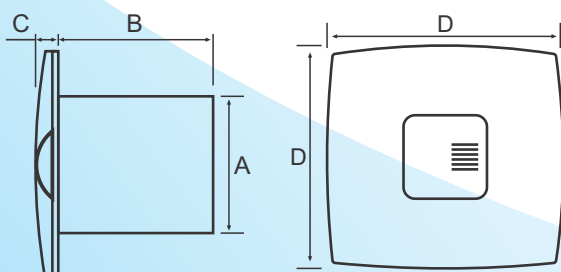

Dimenzije (mm) / *Dimensions (mm)*

TIP / <i>TYPE</i>	ØA	B	C	D
MTG A100XS	100	98	13	140
MTG A120XS	120	100	18	170

GARANCIJA
WARRANTY **5** GODINA
YEARS



MTG A100XS - Ø100

BELI / WHITE



Šifra Code	Model / Model	Opis modela Model description	Pak. Pack.	Bar kod EAN code
29502	MTG A100XS	standard / <i>standard</i>	12	8 605009 127301
29503	MTG A100XS-K	klapna / <i>flap</i>	12	8 605009 127318
29504	MTG A100XS-T	tajmer+klapna / <i>timer+flap</i>	12	8 605009 127325
29505	MTG A100XS-H	higro-tajmer+klapna / <i>hygro-timer+flap</i>	12	8 605009 127332

GARANCIJA
WARRANTY **5** GODINA
YEARS



MTG A100XS - Ø100

SREBRNI / SILVER

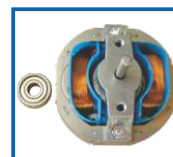

Šifra Code	Model / Model	Opis modela Model description	Pak. Pack.	Bar kod EAN code
29502X	MTG A100XS	standard / <i>standard</i>	12	8 605009 127936
29503X	MTG A100XS-K	klapna / <i>flap</i>	12	8 605009 127943
29504X	MTG A100XS-T	tajmer+klapna / <i>timer+flap</i>	12	8 605009 127950
29505X	MTG A100XS-H	higro-tajmer+klapna / <i>hygro-timer+flap</i>	12	8 605009 127967

napon

230V

voltage

snaga

15W

power

zaštita

IP-X4

protection

brzina

2500
ob/min.
rpm

speed

protok
vazduha

98
m³/h

air flow

nivo buke

37
dB(A)

noise level

masa

0,6
kg

mass

GARANCIJA
WARRANTY **5** GODINA
YEARS



MTG A120XS - Ø120 BELI / **WHITE**

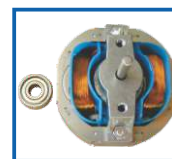

Šifra Code	Model / Model	Opis modela Model description	Pak. Pack.	Bar kod EAN code
29506	MTG A120XS	standard / <i>standard</i>		 8 605009 127448
29507	MTG A120XS-K	klapna / <i>flap</i>		 8 605009 127455
29508	MTG A120XS-T	tajmer+klapna / <i>timer+flap</i>		 8 605009 127462
29509	MTG A120XS-H	higro-tajmer+klapna / <i>hygro-timer+flap</i>		 8 605009 127479

GARANCIJA
WARRANTY **5** GODINA
YEARS



MTG A120XS - Ø120 SREBRNI / **SILVER**

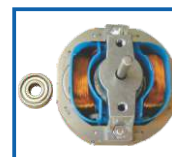

Šifra Code	Model / Model	Opis modela Model description	Pak. Pack.	Bar kod EAN code
29506X	MTG A120XS	standard / <i>standard</i>		 8 605009 128001
29507X	MTG A120XS-K	klapna / <i>flap</i>		 8 605009 128018
29508X	MTG A120XS-T	tajmer+klapna / <i>timer+flap</i>		 8 605009 128025
29509X	MTG A120XS-H	higro-tajmer+klapna / <i>hygro-timer+flap</i>		 8 605009 128032

napon

230V

voltage

snaga

20W

power

zaštita

IP-X4

protection

brzina

2450

ob/min.
rpm

speed

protok
vazduha

190

m³/h
air flow

nivo buke

39

dB(A)
noise level

masa

0,8

kg
mass



Žabice za laku montažu
Easy mounting system



Klapna
Flap

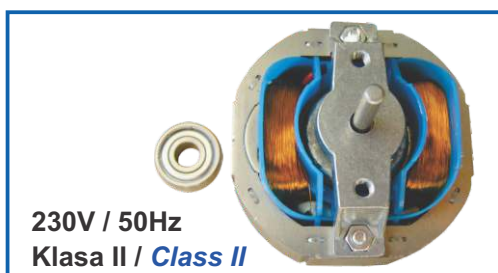

Motor sa termičkom zaštitom (sa ležajem)
Motor with thermal protection (with bearing)

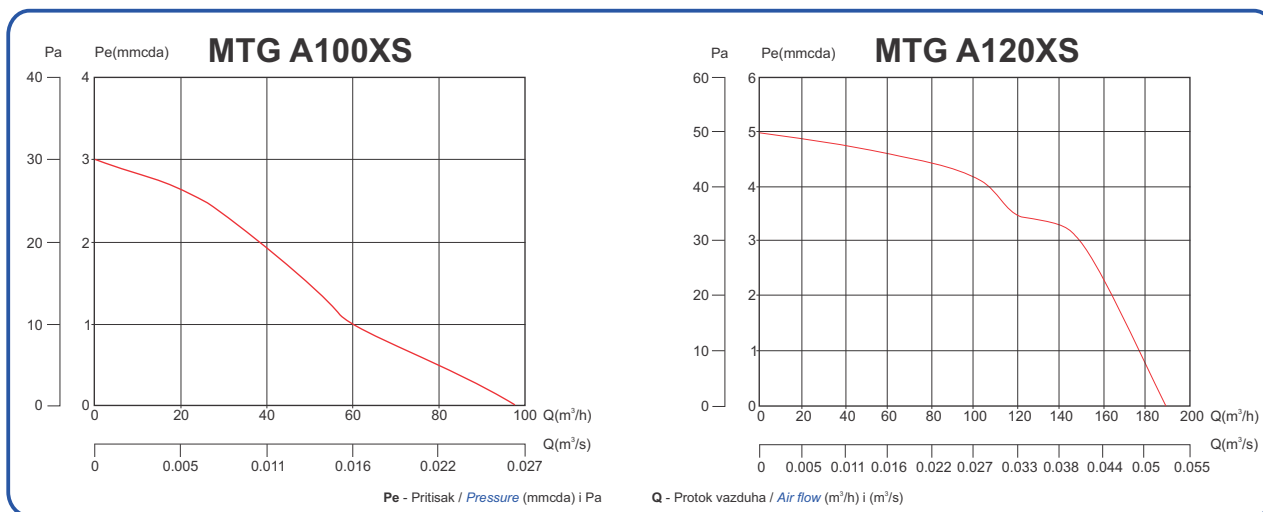

Mogućnost instalacije / Installation:



Na zid
Into a wall opening



Na plafon
Onto ceiling



Brzim zatezanjem žabica u bilo koji otvor
Fast installation by tightening hooks into any opening



A100SXS / A120SXS



Kraće telo ventilatora,
bez žabica za laku montažu
*Shorter ventilator body,
without hooks for easier mounting*



Veoma tihi
Very silent



Lako skidanje panela
Easy removable cover

GARANCIJA 5 GODINA
WARRANTY 5 YEARS

NAMENA VENTILATORA

Ventilatori su dizajnirani za ventilaciju stambenog ili poslovnog prostora. Upotrebljavaju se u prostorijama i na mestima gde je potrebno sprečiti širenje vlage i neprijatnih mirisa. Nisu namenjeni za upotrebu u radnim okruženjima i stambenim prostorijama gde temperatura vazduha prelazi 40°C. Ventilatori su vrlo lagani, poseduju moderan dizajn i odlikuju sa izuzetno tihim radom. Njihova ugradnja je vrlo jednostavna i brza. Telo ventilatora, maska i lopatice elise su izrađeni od kvalitetne plastike. Motor ventilatora opremljen je termičkom zaštitom (B klasa izolacije) koja sprečava dalji rad motora usled njegovog pregrevanja.

PURPOSE OF THE VENTILATOR

The ventilators are designed to ventilate housing or office space. They are used in premises and in places where spreading of humidity and odours needs to be prevented. They are not intended for use in work environments and housing facilities where air temperature exceeds 40°C. The ventilators are very light, with modern design and very silent operation. Its installation is very simple and quick. The ventilator body, mask and blades are made of quality plastic. The ventilator motor has a thermal equipment (insulation class B) which prevents motor overheating.

TEHNIČKE KARAKTERISTIKE:

Ventilator se priključuje na električnu mrežu (električnu struju) od 230V AC i frekvencije od 50Hz. Prema vrsti zaštite od strujnog udara, ventilator pripada uređajima klase II (230V / 50Hz). Ventilator je namenjen za eksploataciju na temperaturi vazduha u prostoriji u opsegu od +1°C do +40°C. Nivo buke na rastojanju od 3m ne prelazi 39dB(A).

TECHNICAL CHARACTERISTICS:

The ventilator is connected to electric power network (electric current) of AC voltage of 230V and 50Hz frequency. When it comes to electric shock protection, the ventilator belongs to Class II (230V / 50Hz). The ventilator is intended for exploitation in air temperatures in the range from +1°C to +40°C. Noise level on 3m distance does not exceed 39dB(A).

MODELI / MODELS:

K - Klapna / FLAP

KP - Klapna+PRIRUBNICA / FLAP+FLANGE

Standard (S)/
Standard (S)



Klapna (K)/
Flap (K)



Prirubnica (P)/
Flange (P)

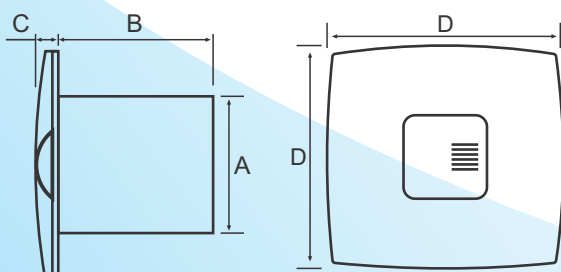

Dimenzije (mm) / *Dimensions (mm)*

TIP / TYPE	ØA	B	C	D
MTG A100SXS	100	75	13	140
MTG A120SXS	120	100	18	170

GARANCIJA 5 GODINA
WARRANTY 5 YEARS



MTG A100SXS - Ø100 BELI / WHITE

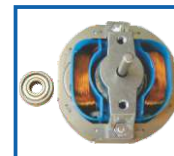

Šifra Code	Model / Model	Opis modela Model description	Pak. Pack.	Bar kod EAN code
29510	MTG A100SXS	standard / <i>standard</i>	12	8 605009 112734 9
29511	MTG A100SXS-K	klapna / <i>flap</i>	12	8 605009 112735 6
29526	MTG A100SXS-KP	klapna+prirubnica / <i>flap+flange</i>	12	8 605009 112736 3

GARANCIJA 5 GODINA
WARRANTY 5 YEARS



MTG A100SXS - Ø100 SREBRNI / SILVER

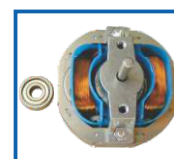

Šifra Code	Model / Model	Opis modela Model description	Pak. Pack.	Bar kod EAN code
29510X	MTG A100SXS	standard / <i>standard</i>	12	8 605009 112797 4
29511X	MTG A100SXS-K	klapna / <i>flap</i>	12	8 605009 112798 1
29526X	MTG A100SXS-KP	klapna+prirubnica / <i>flap+flange</i>	12	8 605009 112799 8

napon 230V voltage	snaga 15W power	zaštita IP-X4 protection	brzina 2500 ob/min. rpm speed	protok vazduha 98 m ³ /h air flow	nivo buke 37 dB(A) noise level	masa 0,6 kg mass
---------------------------------	------------------------------	---------------------------------------	--	---	--	----------------------------------

MTG A100SXS / A120SXS



GARANCIJA 5 GODINA
WARRANTY 5 YEARS



MTG A120SXS - Ø120 BELI / WHITE

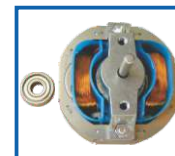

Šifra Code	Model / Model	Opis modela Model description	Pak. Pack.	Bar kod EAN code
29512	MTG A120SXS	standard / <i>standard</i>	12	 8 605009 112748 6
29513	MTG A120SXS-K	klapna / <i>flap</i>	12	 8 605009 112749 3
29527	MTG A120SXS-KP	klapna+prirubnica / <i>flap+flange</i>	12	 8 605009 112750 9

GARANCIJA 5 GODINA
WARRANTY 5 YEARS



MTG A120SXS - Ø120 SREBRNI / SILVER

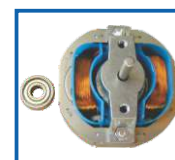

Šifra Code	Model / Model	Opis modela Model description	Pak. Pack.	Bar kod EAN code
29512X	MTG A120SXS	standard / <i>standard</i>	12	 8 605009 112804 9
29513X	MTG A120SXS-K	klapna / <i>flap</i>	12	 8 605009 112805 6
29527X	MTG A120SXS-KP	klapna+prirubnica / <i>flap+flange</i>	12	 8 605009 112806 3

napon

230V

voltage

snaga

20W

power

zaštita

IP-X4

protection

brzina

2450

ob/min.
rpm

speed

protok
vazduha

190

m³/h
air flow

nivo buke

39

dB(A)
noise level

masa

0,8

kg
mass



Klapna
Flap



Prirubnica
Flange

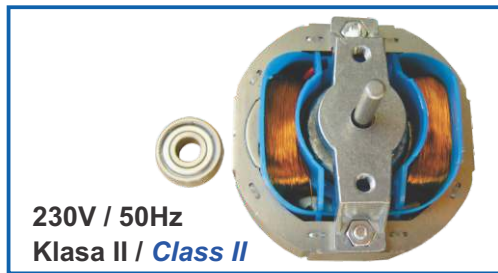

Motor sa termičkom zaštitom (sa ležajem)
Motor with thermal protection (with bearing)

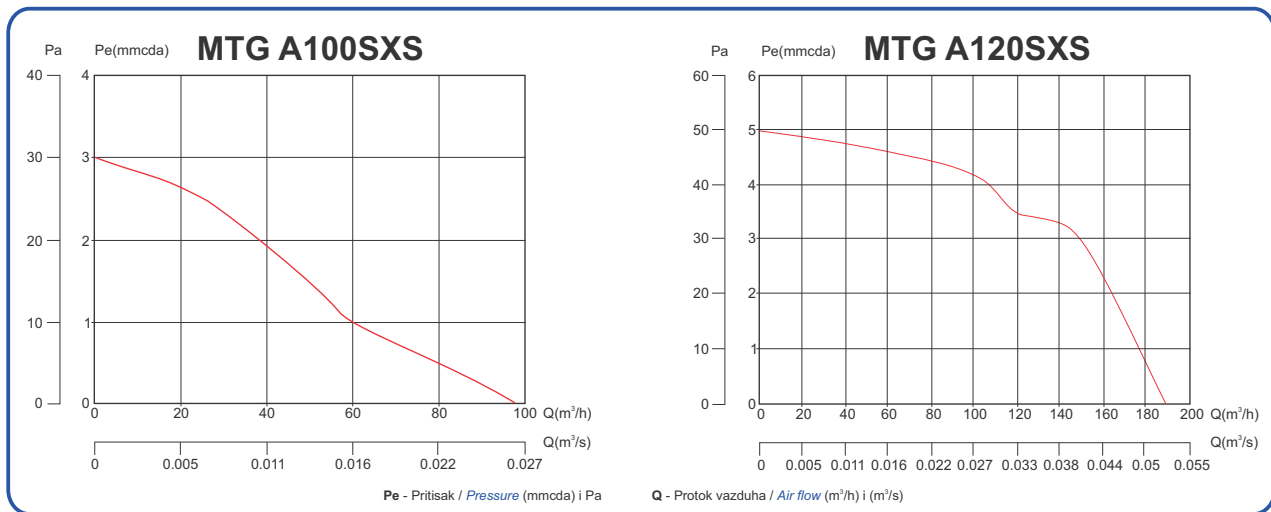

Mogućnost instalacije / Installation:



Na zid
Into a wall opening



Na plafon
Onto ceiling

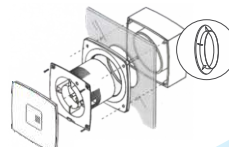

Na Prozor
(pomoću prirubnice)
*On window
(with flange)*

MTG A120XS / Ø150



GARANCIJA
WARRANTY **5** GODINA
YEARS



Ø 120 + = Ø 150



Šifra Code	Model / Model	Opis modela Model description	Pak. Pack.	Bar kod EAN code
31201	MTG A120XS / Ø150	standard / <i>standard</i>		
31202	MTG A120XS-K / Ø150	klapna / <i>flap</i>		
31203	MTG A120XS-T / Ø150	tajmer+klapna / <i>timer+flap</i>		
31204	MTG A120XS-H / Ø150	higro-tajmer+klapna / <i>hygro-timer+flap</i>		

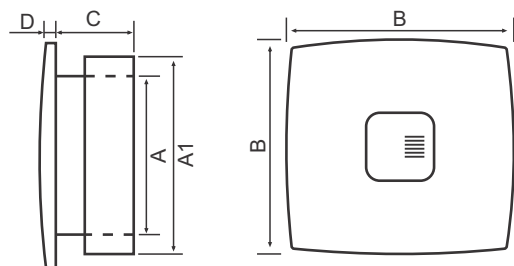

Dimenzije (mm) / *Dimensions (mm)*

TIP / TYPE	ØA	ØA1	B	C	D
MTG A120XS / Ø150	120	150	170	100	18

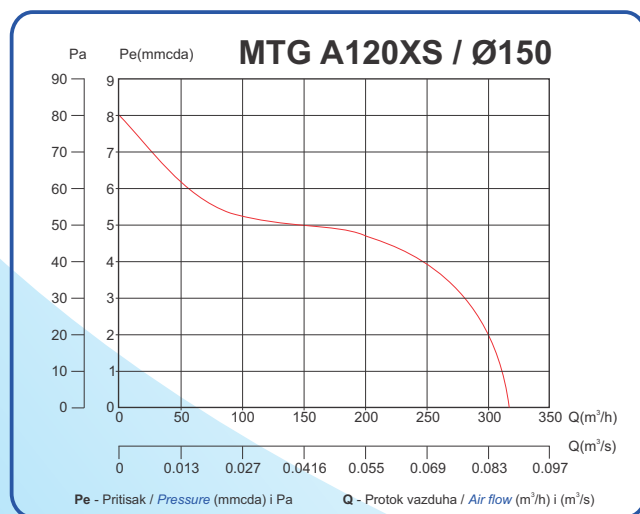

Motor sa termičkom zaštitom (sa ležajem)
Motor with thermal protection (with bearing)

Mogućnost instalacije / *Installation:*



Na zid
Into a wall opening



Na plafon
Onto ceiling

napon

230V

voltage

snaga

25W

power

zaštita

IP-X4

protection

brzina

2600
ob/min.
rpm

speed

protok
vazduha

320
m³/h

air flow

nivo buke

41
dB(A)

noise level

masa

0,85
kg

mass



A100 / A120



Duže telo ventilatora,
žabice za laku montažu
*Longer ventilator body,
hooks for easier mounting*

NAMENA VENTILATORA

Ventilatori su dizajnirani za ventilaciju stambenog ili poslovnog prostora. Upotrebljavaju se u prostorijama i na mestima gde je potrebno sprečiti širenje vlage i neprijatnih mirisa. Nisu namenjeni za upotrebu u radnim okruženjima i stambenim prostorijama gde temperatura vazduha prelazi 40°C. Ventilatori su vrlo lagani, poseduju moderan dizajn i odlikuju sa izuzetno tihim radom. Njihova ugradnja je vrlo jednostavna i brza. Telo ventilatora, maska i lopatice elise su izrađeni od kvalitetne plastike. Motor ventilatora opremljen je termičkom zaštitom (B klasa izolacije) koja sprečava dalji rad motora usled njegovog pregrevanja.

PURPOSE OF THE VENTILATOR

The ventilators are designed to ventilate housing or office space. They are used in premises and in places where spreading of humidity and odours needs to be prevented. They are not intended for use in work environments and housing facilities where air temperature exceeds 40°C. The ventilators are very light, with modern design and very silent operation. Its installation is very simple and quick. The ventilator body, mask and blades are made of quality plastic. The ventilator motor has a thermal equipment (insulation class B) which prevents motor overheating.

TEHNIČKE KARAKTERISTIKE:

Ventilator se priključuje na električnu mrežu (električnu struju) od 230V AC i frekvencije od 50Hz. Prema vrsti zaštite od strujnog udara, ventilator pripada uređajima klase II (230V / 50Hz). Ventilator je namenjen za eksploataciju na temperaturi vazduha u prostoriji u opsegu od +1°C do +40°C. Nivo buke na rastojanju od 3m ne prelazi 43dB(A).

TECHNICAL CHARACTERISTICS:

The ventilator is connected to electric power network (electric current) of AC voltage of 230V and 50Hz frequency. When it comes to electric shock protection, the ventilator belongs to Class II (230V / 50Hz). The ventilator is intended for exploitation in air temperatures in the range from +1°C to +40°C. Noise level on 3m distance does not exceed 43dB(A).

MODELI / MODELS:

T - TAJMER+KLAPNA / *TIMER+FLAP*
H - HIGRO-TAJMER+KLAPNA / *HYGROTIMER+FLAP*
PP - POTEZNI PREKIDAČ / *PULL SWITCH*
K - KLAPNA / *FLAP*
PPK - POTEZNI PREKIDAČ+KLAPNA / *PULL SWITCH+FLAP*

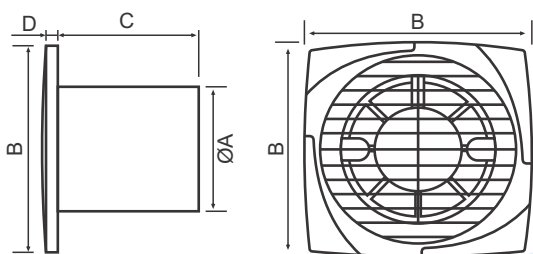

Dimenzije (mm) / *Dimensions (mm)*

TIP / <i>TYPE</i>	ØA	B	C	D
MTG A100	98	140	98	10
MTG A120	118	170	100	13

MTG A100 / A120



BELI / WHITE



MTG A100 - Ø100

Šifra Code	Model / Model	Opis modela Model description	Pak. Pack.	Bar kod EAN code
12257	MTG A100	standard / <i>standard</i>		 8 605009 110007 6
12260	MTG A100-T	tajmer+klapna / <i>timer+flap</i>		 8 605009 110009 0
12261	MTG A100-H	higro-tajmer+klapna / <i>hygro-timer+flap</i>		 8 605009 110010 6
12458	MTG A100-PP	potezni prekidač / <i>pull switch</i>		 8 605009 110015 1
12258	MTG A100-K	klapna / <i>flap</i>		 8 605009 110008 3
9888	MTG A100-PPK	potezni prekidač+klapna / <i>pull switch+flap</i>		 8 605009 110151 6



ANTRACIT / ANTHRACITE



MTG A100 - Ø100

Šifra Code	Model / Model	Opis modela Model description	Pak. Pack.	Bar kod EAN code
18946	MTG A100	standard / <i>standard</i>		 8 605009 110153 0
19624	MTG A100-T	tajmer+klapna / <i>timer+flap</i>		 8 605009 111277 2
19620	MTG A100-H	higro-tajmer+klapna / <i>hygro-timer+flap</i>		 8 605009 111273 4
19622	MTG A100-PP	potezni prekidač / <i>pull switch</i>		 8 605009 111275 8
19621	MTG A100-K	klapna / <i>flap</i>		 8 605009 111274 1
19623	MTG A100-PPK	potezni prekidač+klapna / <i>pull switch+flap</i>		 8 605009 111276 5

napon

230V

voltage

snaga

15W

power

zaštita

IP-X4

protection

brzina

2500
ob/min.
rpm

speed

protok
vazduha

98
m³/h

air flow

nivo buke

41
dB(A)

noise level

masa

0,6
kg

mass

MTG A120 - Ø120



BELI / **WHITE**



Šifra Code	Model / Model	Opis modela Model description	Pak. Pack.	Bar kod EAN code
12262	MTG A120	standard / <i>standard</i>		 8 605009 1100113
12264	MTG A120-T	tajmer+klapna / <i>timer+flap</i>		 8 605009 1100137
12265	MTG A120-H	higro-tajmer+klapna / <i>hygro-timer+flap</i>		 8 605009 1100144
4559	MTG A120-PP	potezni prekidač / <i>pull switch</i>		 8 605009 1100168
12263	MTG A120-K	klapna / <i>flap</i>		 8 605009 1100120
11330	MTG A120-PPK	potezni prekidač+klapna / <i>pull switch+flap</i>		 8 605009 1101523

MTG A120 - Ø120



ANTRACIT / **ANTHRACITE**



Šifra Code	Model / Model	Opis modela Model description	Pak. Pack.	Bar kod EAN code
18947	MTG A120	standard / <i>standard</i>		 8 605009 1101547
19629	MTG A120-T	tajmer+klapna / <i>timer+flap</i>		 8 605009 1112826
19625	MTG A120-H	higro-tajmer+klapna / <i>hygro-timer+flap</i>		 8 605009 1112789
19627	MTG A120-PP	potezni prekidač / <i>pull switch</i>		 8 605009 1112802
19626	MTG A120-K	klapna / <i>flap</i>		 8 605009 1112796
19628	MTG A120-PPK	potezni prekidač+klapna / <i>pull switch+flap</i>		 8 605009 1112819

napon

230V

voltage

snaga

20W

power

zaštita

IP-X4

protection

brzina

2450
ob/min.
rpm

speed

protok
vazduha

190
m³/h

air flow

nivo buke

43
dB(A)

noise level

masa

0,8
kg

mass



Žabice za laku montažu
Easy mounting system



Klapna
Flap



230V / 50Hz
Klasa II / Class II

Motor sa termičkom zaštitom
Motor with thermal protection

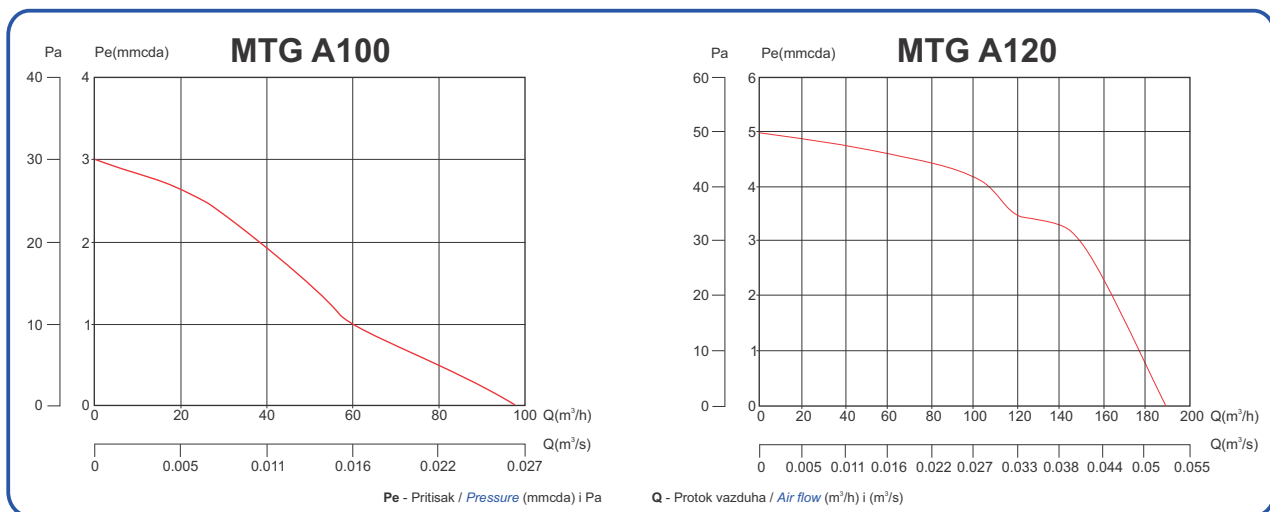

Mogućnost instalacije / Installation:

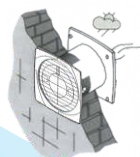

Na zid
Into a wall opening

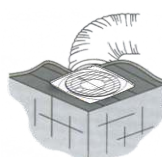

Na plafon
Onto ceiling

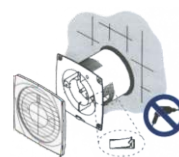

Brzim zatezanjem žabica u bilo koji otvor
Fast installation by tightening hooks into any opening



A100S / A120S



KRATKA CEV

SHORT TUBE

Kraće telo ventilatora,
bez žabica za laku montažu
*Shorter ventilator body,
without hooks for easier mounting*

NAMENA VENTILATORA

Ventilatori su dizajnirani za ventilaciju stambenog ili poslovnog prostora. Upotrebljavaju se u prostorijama i na mestima gde je potrebno sprečiti širenje vlage i neprijatnih mirisa. Nisu namenjeni za upotrebu u radnim okruženjima i stambenim prostorijama gde temperatura vazduha prelazi 40°C. Ventilatori su vrlo lagani, poseduju moderan dizajn i odlikuju sa izuzetno tihim radom. Njihova ugradnja je vrlo jednostavna i brza. Telo ventilatora, maska i lopatice elise su izrađeni od kvalitetne plastike. Motor ventilatora opremljen je termičkom zaštitom (B klasa izolacije) koja sprečava dalji rad motora usled njegovog pregrevanja.

PURPOSE OF THE VENTILATOR

The ventilators are designed to ventilate housing or office space. They are used in premises and in places where spreading of humidity and odours needs to be prevented. They are not intended for use in work environments and housing facilities where air temperature exceeds 40°C. The ventilators are very light, with modern design and very silent operation. Its installation is very simple and quick. The ventilator body, mask and blades are made of quality plastic. The ventilator motor has a thermal equipment (insulation class B) which prevents motor overheating.

TEHNIČKE KARAKTERISTIKE:

Ventilator se priključuje na električnu mrežu (električnu struju) od 230V AC i frekvencije od 50Hz. Prema vrsti zaštite od strujnog udara, ventilator pripada uređajima klase II (230V / 50Hz). Ventilator je namenjen za eksploataciju na temperaturi vazduha u prostoriji u opsegu od +1°C do +40°C. Nivo buke na rastojanju od 3m ne prelazi 43dB(A).

TECHNICAL CHARACTERISTICS:

The ventilator is connected to electric power network (electric current) of AC voltage of 230V and 50Hz frequency. When it comes to electric shock protection, the ventilator belongs to Class II (230V / 50Hz). The ventilator is intended for exploitation in air temperatures in the range from +1°C to +40°C. Noise level on 3m distance does not exceed 43dB(A).

MODELI / MODELS:

K - Klapna / *FLAP*
PP - POTEZNI PREKIDAČ / *PULL SWITCH*
PPK - POTEZNI PREKIDAČ+KLAPNA / *PULL SWITCH+FLAP*
P - PRIRUBNICA / *FLANGE*
KP - Klapna+PRIRUBNICA / *FLAP+FLANGE*

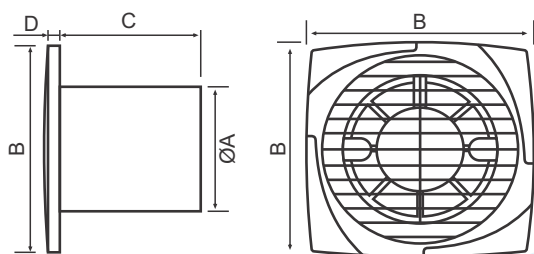
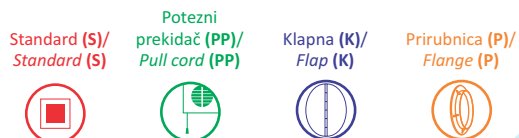

Dimenzije (mm) / *Dimensions (mm)*

TIP / <i>TYPE</i>	ØA	B	C	D
MTG A100S	98	140	75	10
MTG A120S	118	170	100	13

MTG A100S / A120S



MTG A100S - Ø100

BELI / WHITE



Šifra Code	Model / Model	Opis modela Model description	Pak. Pack.	Bar kod EAN code
12257A	MTG A100S	standard / <i>standard</i>		 8 605009 126045
12258A	MTG A100S-K	klapna / <i>flap</i>		 8 605009 126052
12458A	MTG A100S-PP	potezni prekidač / <i>pull switch</i>		 8 605009 126076
9888A	MTG A100S-PPK	potezni prekidač+klapna / <i>pull switch+flap</i>		 8 605009 126083
20541A	MTG A100S-P	prirubnica / <i>flange</i>		 8 605009 126069
20543A	MTG A100S-KP	klapna+prirubnica / <i>flap+flange</i>		 8 605009 126090



MTG A100S - Ø100

ANTRACIT / ANTHRACITE



Šifra Code	Model / Model	Opis modela Model description	Pak. Pack.	Bar kod EAN code
18946A	MTG A100S	standard / <i>standard</i>		 8 605009 128506
19621A	MTG A100S-K	klapna / <i>flap</i>		 8 605009 128513
19622A	MTG A100S-PP	potezni prekidač / <i>pull switch</i>		 8 605009 128520
19623A	MTG A100S-PPK	potezni prekidač+klapna / <i>pull switch+flap</i>		 8 605009 128537
29375A	MTG A100S-P	prirubnica / <i>flange</i>		 8 605009 128544
29376A	MTG A100S-KP	klapna+prirubnica / <i>flap+flange</i>		 8 605009 128551

napon
230V
voltage

snaga
15W
power

zaštita
IP-X4
protection

brzina
2500
ob/min.
rpm
speed

protok
vazduha
98
m³/h
air flow

nivo buke
41
dB(A)
noise level

masa
0,6
kg
mass



BELI / *WHITE*



MTG A120S - Ø120

Šifra <i>Code</i>	Model / <i>Model</i>	Opis modela <i>Model description</i>	Pak. <i>Pack.</i>	Bar kod <i>EAN code</i>
12262A	MTG A120S	standard / <i>standard</i>		
12263A	MTG A120S-K	klapna / <i>flap</i>		
4559A	MTG A120S-PP	potezni prekidač / <i>pull switch</i>		
11330A	MTG A120S-PPK	potezni prekidač+klapna / <i>pull switch+flap</i>		
12264A	MTG A120S-T	tajmer+klapna / <i>timer+flap</i>		
12265A	MTG A120S-H	higro-tajmer+klapna / <i>hygro-timer+flap</i>		
20542A	MTG A120S-P	prirubnica / <i>flange</i>		
20544A	MTG A120S-KP	klapna+prirubnica / <i>flap+flange</i>		

napon

230V

voltage

snaga

20W

power

zaštita

IP-X4

protection

brzina

2450
ob/min.
rpm

speed

protok
vazduha

190
m³/h

air flow

nivo buke

43
dB(A)

noise level

masa

0,8
kg

mass



MTG A120S - Ø120

ANTRACIT / ANTHRACITE

Šifra Code	Model / Model	Opis modela Model description	Pak. Pack.	Bar kod EAN code
18947A	MTG A120S	standard / <i>standard</i>		 8 605009 128568
19626A	MTG A120S-K	klapna / <i>flap</i>		 8 605009 128575
19627A	MTG A120S-PP	potezni prekidač / <i>pull switch</i>		 8 605009 128582
19628A	MTG A120S-PPK	potezni prekidač+klapna / <i>pull switch+flap</i>		 8 605009 128599
19629A	MTG A120S-T	tajmer+klapna / <i>timer+flap</i>		 8 605009 128605
19625A	MTG A120S-H	higro-tajmer+klapna / <i>hygro-timer+flap</i>		 8 605009 128612
29377A	MTG A120S-P	prirubnica / <i>flange</i>		 8 605009 128629
29378A	MTG A120S-KP	klapna+prirubnica / <i>flap+flange</i>		 8 605009 128636

napon

230V

voltage

snaga

20W

power

zaštita

IP-X4

protection

brzina

2450

ob/min.
rpm

speed

protok
vazduha

190

m³/h

air flow

nivo buke

43

dB(A)

noise level

masa

0,8

kg

mass



Klapna
Flap



Prirubnica
Flange



230V / 50Hz
Klasa II / Class II

Motor sa termičkom zaštitom
Motor with thermal protection

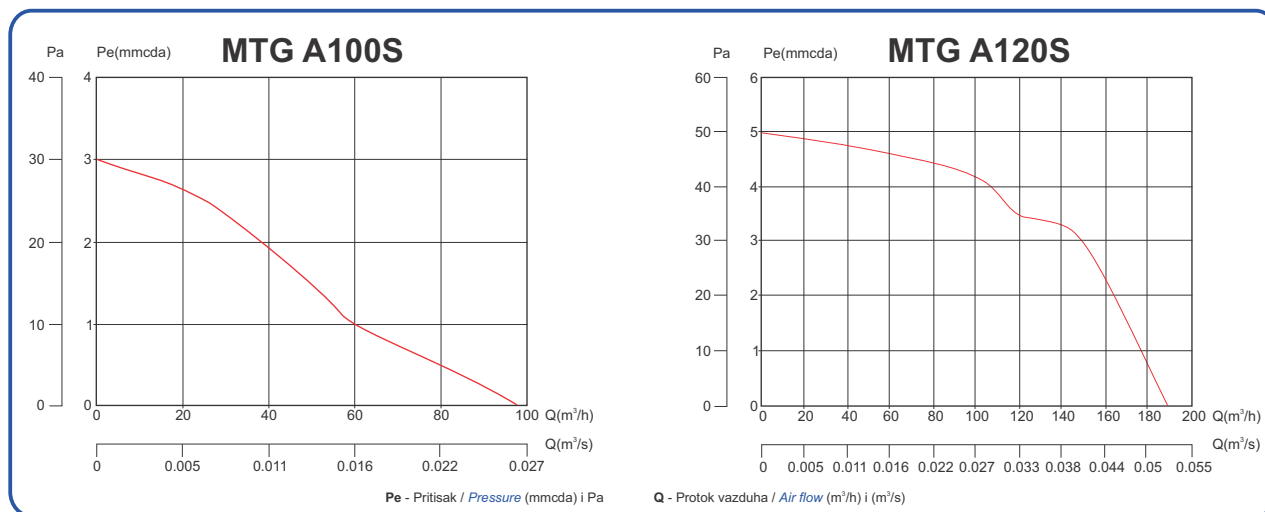

Mogućnost instalacije / Installation:

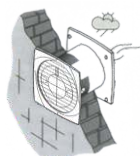

Na zid
Into a wall opening

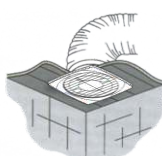

Na plafon
Onto ceiling

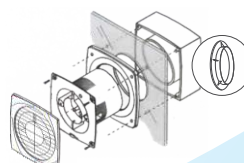













Na Prozor
(pomoću prirubnice)
On window
(with flange)

MTG A120 / Ø150



Ø 120 +  = Ø 150

Šifra Code	Model / Model	Opis modela Model description	Pak. Pack.	Bar kod EAN code
31184	MTG A120 / Ø150	standard / <i>standard</i>	 12	 8 605009 128148
31186	MTG A120-K / Ø150	klapna / <i>flap</i>	 12	 8 605009 128162
31187	MTG A120-PP / Ø150	potezni prekidač / <i>pull switch</i>	 12	 8 605009 128179
31188	MTG A120-PPK / Ø150	potezni prekidač+klapna / <i>pull switch+flap</i>	 12	 8 605009 128186
31189	MTG A120-T / Ø150	tajmer+klapna / <i>timer+flap</i>	 12	 8 605009 128193
31185	MTG A120-H / Ø150	higro-tajmer+klapna / <i>hygro-timer+flap</i>	 12	 8 605009 128155

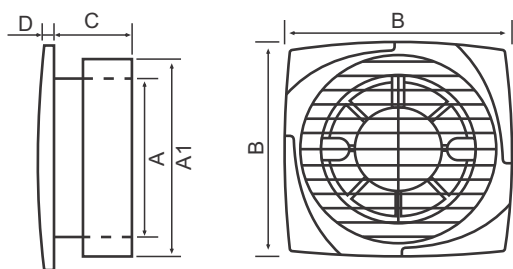

Dimenzije (mm) / *Dimensions (mm)*

TIP / TYPE	ØA	ØA1	B	C	D
MTG A120 / fi 150	120	150	170	100	13

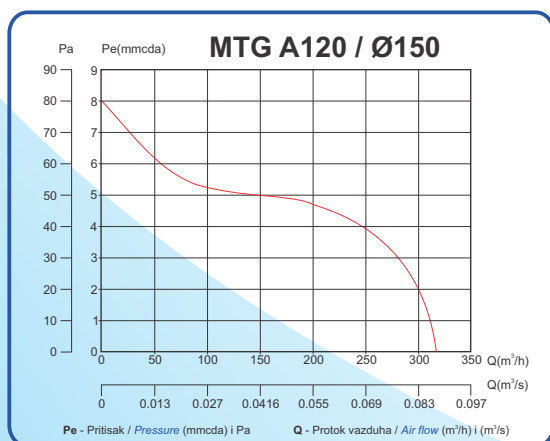

230V / 50Hz
Klasa II / *Class II*



Motor sa termičkom zaštitom
Motor with thermal protection

Mogućnost instalacije / *Installation:*

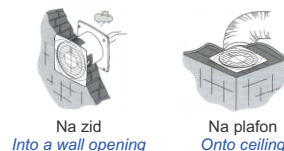

napon

230V

voltage

snaga

25W

power

zaštita

IP-X4

protection

brzina

2600

ob/min.

rpm

speed

protok
vazduha

320

m³/h

air flow

nivo buke

45

dB(A)

noise level

masa

0,85

kg

mass



NAMENA VENTILATORA

Ventilatori su dizajnirani za ventilaciju stambenog ili poslovnog prostora. Upotrebljavaju se u prostorijama i na mestima gde je potrebno sprečiti širenje vlage i neprijatnih mirisa. Nisu namenjeni za upotrebu u radnim okruženjima i stambenim prostorijama gde temperatura vazduha prelazi 40°C. Ventilatori su vrlo lagani, poseduju moderan dizajn i odlikuju sa izuzetno tihim radom. Njihova ugradnja je vrlo jednostavna i brza. Telo ventilatora, maska i lopatice elise su izrađeni od kvalitetne plastike. Motor ventilatora opremljen je termičkom zaštitom (B klasa izolacije) koja sprečava dalji rad motora usled njegovog pregrevanja.

PURPOSE OF THE VENTILATOR

The ventilators are designed to ventilate housing or office space. They are used in premises and in places where spreading of humidity and odours needs to be prevented. They are not intended for use in work environments and housing facilities where air temperature exceeds 40°C. The ventilators are very light, with modern design and very silent operation. Its installation is very simple and quick. The ventilator body, mask and blades are made of quality plastic. The ventilator motor has a thermal equipment (insulation class B) which prevents motor overheating.

TEHNIČKE KARAKTERISTIKE:

Ventilator se priključuje na električnu mrežu (električnu struju) od 230V AC i frekvencije od 50Hz. Prema vrsti zaštite od strujnog udara, ventilator pripada uređajima klase II (230V / 50Hz). Ventilator je namenjen za eksploataciju na temperaturi vazduha u prostoriji u opsegu od +1°C do +40°C. Nivo buke na rastojanju od 3m ne prelazi 43dB(A).

TECHNICAL CHARACTERISTICS:

The ventilator is connected to electric power network (electric current) of AC voltage of 230V and 50Hz frequency. When it comes to electric shock protection, the ventilator belongs to Class II (230V / 50Hz). The ventilator is intended for exploitation in air temperatures in the range from +1°C to +40°C. Noise level on 3m distance does not exceed 43dB(A).

MODELI / MODELS:

PP - POTEZNI PREKIDAČ / *PULL SWITCH*
 K - Klapna / *FLAP*
 PPK - POTEZNI PREKIDAČ+KLAPNA / *PULL SWITCH+FLAP*
 P - PRIRUBNICA / *FLANGE*
 KP - Klapna+PRIRUBNICA / *FLAP+FLANGE*

Standard (S)/
Standard (S)



Potezni
prekidač (PP)/
Pull cord (PP)



Klapna (K)/
Flap (K)



Prirubnica (P)/
Flange (P)

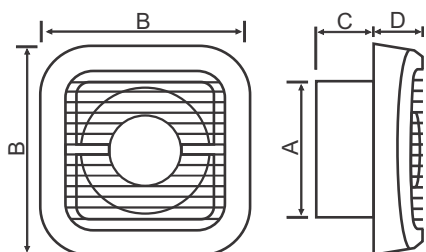

Dimenzije (mm) / *Dimensions (mm)*

TIP / <i>TYPE</i>	ØA	B	C	D
MTG A100N	98	153	45	37
MTG A120N	118	180	50	37

MTG A100N / A120N



MTG A100N - Ø100

BELI / WHITE



Šifra Code	Model / Model	Opis modela Model description	Pak. Pack.	Bar kod EAN code
17737	MTG A100N	standard / <i>standard</i>		
17738	MTG A100N-K	klapna / <i>flap</i>		
20545	MTG A100N-P	prirubnica / <i>flange</i>		
20547	MTG A100N-KP	klapna+prirubnica / <i>flap+flange</i>		
22446	MTG A100N-PPK	potezni prekidač+klapna / <i>pull switch+flap</i>		



MTG A100N - Ø100

ANTRACIT / ANTHRACITE



Šifra Code	Model / Model	Opis modela Model description	Pak. Pack.	Bar kod EAN code
22416	MTG A100N	standard / <i>standard</i>		
22417	MTG A100N-K	klapna / <i>flap</i>		
22418	MTG A100N-P	prirubnica / <i>flange</i>		
22419	MTG A100N-KP	klapna+prirubnica / <i>flap+flange</i>		
22458	MTG A100N-PPK	potezni prekidač+klapna / <i>pull switch+flap</i>		

napon

230V

voltage

snaga

15W

power

zaštita

IP-X4

protection

brzina

2500
ob/min.
rpm

speed

protok
vazduha

98
m³/h

air flow

nivo buke

41
dB(A)

noise level

masa

0,6
kg

mass



MTG A120N - Ø120

BELI / WHITE



Šifra Code	Model / Model	Opis modela Model description	Pak. Pack.	Bar kod EAN code
17739	MTG A120N	standard / <i>standard</i>	12	8 605009 124713
17740	MTG A120N-K	klapna / <i>flap</i>	12	8 605009 124737
20546	MTG A120N-P	prirubnica / <i>flange</i>	12	8 605009 124775
20548	MTG A120N-KP	klapna+prirubnica / <i>flap+flange</i>	12	8 605009 124751
22447	MTG A120N-PPK	potezni prekidač+klapna / <i>pull switch+flap</i>	12	8 605009 124799



MTG A120N - Ø120

ANTRACIT / ANTHRACITE



Šifra Code	Model / Model	Opis modela Model description	Pak. Pack.	Bar kod EAN code
22420	MTG A120N	standard / <i>standard</i>	12	8 605009 124720
22421	MTG A120N-K	klapna / <i>flap</i>	12	8 605009 124744
22422	MTG A120N-P	prirubnica / <i>flange</i>	12	8 605009 124782
22423	MTG A120N-KP	klapna+prirubnica / <i>flap+flange</i>	12	8 605009 124768
22459	MTG A120N-PPK	potezni prekidač+klapna / <i>pull switch+flap</i>	12	8 605009 124805

napon	snaga	zaštita	brzina	protok vazduha	nivo buke	masa
230V	20W	IP-X4	2450 ob/min. rpm	190 m ³ /h	43 dB(A)	0,8 kg
voltage	power	protection	speed	air flow	noise level	mass



Klapna
Flap



Prirubnica
Flange

230V / 50Hz - Klasa II / *Class II*



Motor sa termičkom zaštitom
Motor with thermal protection

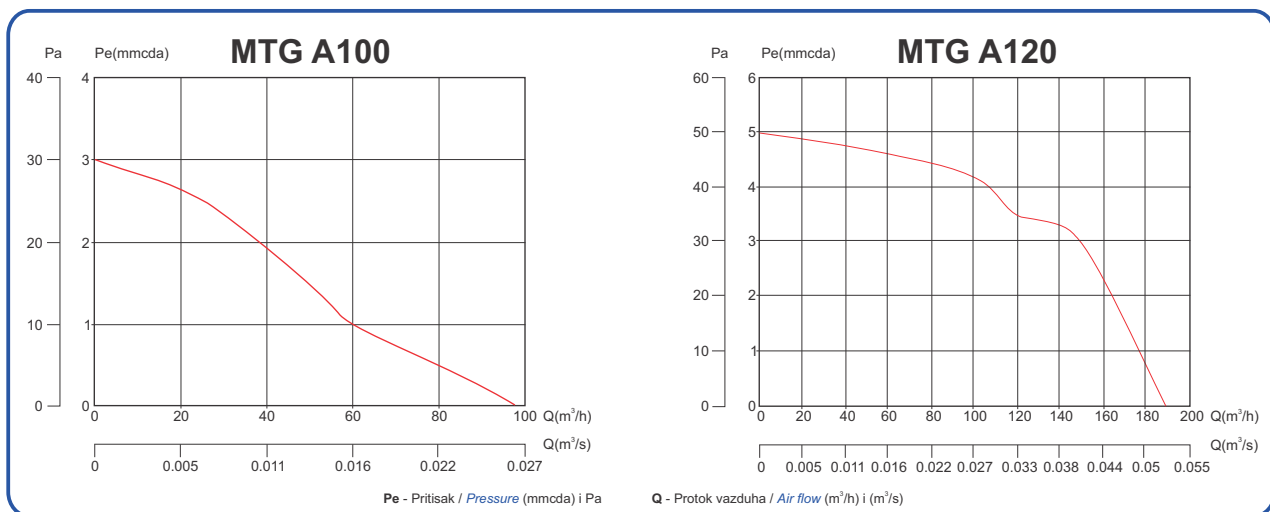

Mogućnost instalacije / *Installation:*



Na zid
Into a wall opening





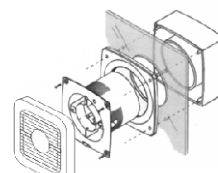



Na plafon
Onto ceiling



Na Prozor
On window



Ø 120 +  = Ø 150

Šifra Code	Model / Model	Opis modela Model description	Pak. Pack.	Bar kod EAN code
31198	MTG A120N / Ø150	standard / <i>standard</i>		 8 605009 128209
31199	MTG A120N-K / Ø150	klapna / <i>flap</i>		 8 605009 128216
31200	MTG A120N-PPK / Ø150	potezni prekidač / <i>pull switch</i>		 8 605009 128223

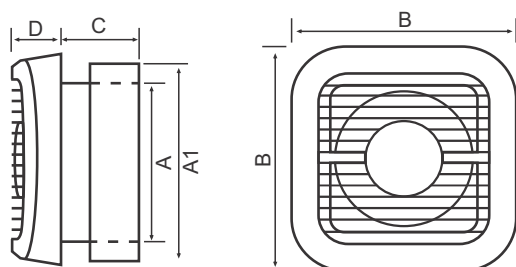

Dimenzije (mm) / *Dimensions (mm)*

TIP / TYPE	ØA	ØA1	B	C	D
MTG A120 / fi 150	120	150	180	50	37

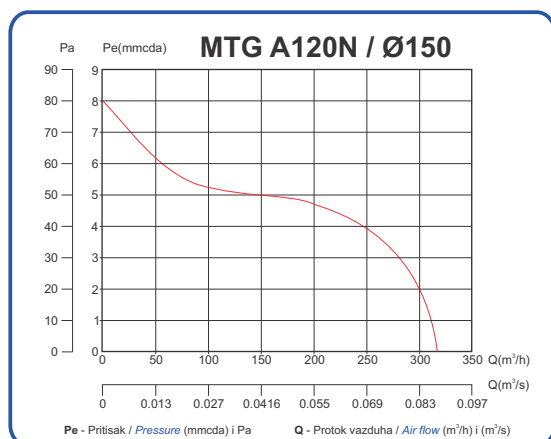

230V / 50Hz
Klasa II / *Class II*



Motor sa termičkom zaštitom
Motor with thermal protection

Mogućnost instalacije / *Installation:*

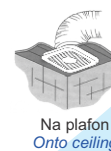

napon 230V voltage	snaga 25W power	zaštita IP-X4 protection	brzina 2600 ob/min. rpm speed	protok vazduha 320 m³/h air flow	nivo buke 45 dB(A) noise level	masa 0,85 kg mass
---------------------------------	------------------------------	---------------------------------------	--	---	--	-----------------------------------



NAMENA VENTILATORA

Cevni ventilatori A100C i A120C namenjeni su za kvalitetno obezbeđenje prirodne ventilacije u prostorijama koje poseduju neophodne ventilacione vodove. Zahvaljujući konstruktivnim karakteristikama, cevni aspiratori, za kratko vreme, omogućavaju otpremanje velike količine neprijatnih mirisa, dima, raznih isparenja i vlage. Unošenjem svežeg vazduha, uređaj brzo uspostavlja ekološku ravnotežu vazdušne zapremine prostorije. Nisu namenjeni za upotrebu u radnim okruženjima i stambenim prostorijama gde temperatura vazduha prelazi 40°C.

Ventilatori poseduju moderan dizajn i odlikuju se izuzetno tihim radom. Njihova ugradnja je vrlo jednostavna.

Telo ventilatora i lopatice elise su izrađeni od kvalitetne plastike.

Motor ventilatora opremljen je termičkom zaštitom (B klasa izolacije) koja sprečava dalji rad motora usled njegovog pregrevanja.

PURPOSE OF THE VENTILATOR

Tube ventilators A100C and A120C are intended to provide high quality natural ventilation in rooms that have the necessary ventilation ducts. Thanks to their construction features, tube ventilators, in a short time, allow evacuation of large amounts of unpleasant smells, smoke, various fumes and moisture. By bringing in the fresh air, the device quickly establishes ecological balance of the air volume of a room. They are not intended for use in work environments and housing facilities where air temperature exceeds 40°C.

The ventilators are with modern design and very silent operation. Their installation is very simple. Its installation is very simple and quick. The ventilator body, mask and blades are made of quality plastic.

The ventilator motor has a thermal equipment (insulation class B) which prevents motor overheating.

TEHNIČKE KARAKTERISTIKE:

Ventilator se priključuje na električnu mrežu (električnu struju) od 230V AC i frekvencije od 50Hz.

Prema vrsti zaštite od strujnog udara, ventilator pripada uređajima klase II (230V / 50Hz).

Ventilator je namenjen za eksploataciju na temperaturi vazduha u prostoriji u opsegu od +1°C do +40°C.

Nivo buke na rastojanju od 3m ne prelazi 43dB(A).

TECHNICAL CHARACTERISTICS:

The ventilator is connected to electric power network (electric current) of AC voltage of 230V and 50Hz frequency.

When it comes to electric shock protection, the ventilator belongs to Class II (230V / 50Hz).

The ventilator is intended for exploitation in air temperatures in the range from +1°C to +40°C.

Noise level on 3m distance does not exceed 43dB(A).

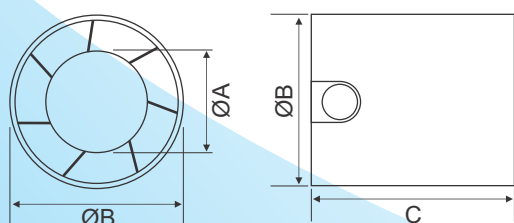

Dimenzije (mm) / Dimensions (mm)

TIP / TYPE	ØA	ØB	C
MTG A100C	60	97	92
MTG A120C	60	118	96

MTG A100C - Ø100



Šifra Code	Model / Model	Opis modela Model description	Pak. Pack.	Bar kod EAN code
4566	MTG A100C	standard / standard		 8 605009 101493

napon 230V voltage	snaga 15W power	zaštita IP-X4 protection	brzina 2500 ob/min. rpm speed	protok vazduha 98 m ³ /h air flow	nivo buke 41 dB(A) noise level	masa 0,41 kg mass
---------------------------------	------------------------------	---------------------------------------	--	---	--	-----------------------------------

MTG A120C - Ø120



Šifra Code	Model / Model	Opis modela Model description	Pak. Pack.	Bar kod EAN code
4613	MTG A120C	standard / standard		 8 605009 101509

napon 230V voltage	snaga 20W power	zaštita IP-X4 protection	brzina 2450 ob/min. rpm speed	protok vazduha 190 m ³ /h air flow	nivo buke 43 dB(A) noise level	masa 0,6 kg mass
---------------------------------	------------------------------	---------------------------------------	--	--	--	----------------------------------

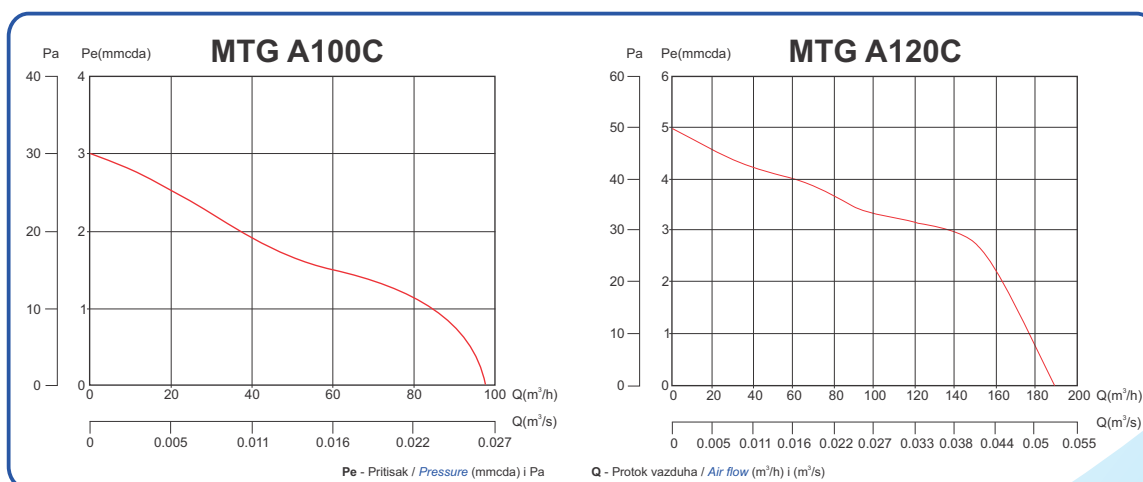

230V / 50Hz
Klasa II / Class II



Motor sa termičkom zaštitom
Motor with thermal protection

Mogućnost instalacije / Installation:

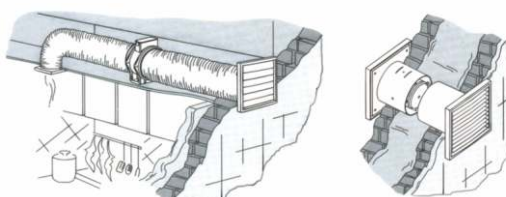



GARANCIJA 5 GODINA
WARRANTY 5 YEARS

NAMENA VENTILATORA

Cevni ventilatori A100CS i A120CS namenjeni su za kvalitetno obezbeđenje prirodne ventilacije u prostorijama koje poseduju neophodne ventilacione vodove. Zahvaljujući konstruktivnim karakteristikama, cevni aspiratori, za kratko vreme, omogućavaju otpremanje velike količine neprijatnih mirisa, dima, raznih isparenja i vlage. Unošenjem svežeg vazduha, uređaj brzo uspostavlja ekološku ravnotežu vazdušne zapremine prostorije. Nisu namenjeni za upotrebu u radnim okruženjima i stambenim prostorijama gde temperatura vazduha prelazi 40°C.

Ventilatori poseduju moderan dizajn i odlikuju se izuzetno tihim radom. Njihova ugradnja je vrlo jednostavna.

Telo ventilatora i lopatice elise su izrađeni od kvalitetne plastike.

Motor ventilatora opremljen je termičkom zaštitom (B klasa izolacije) koja sprečava dalji rad motora usled njegovog pregrevanja.

PURPOSE OF THE VENTILATOR

Tube ventilators A100CS and A120CS are intended to provide high quality natural ventilation in rooms that have the necessary ventilation ducts. Thanks to their construction features, tube ventilators, in a short time, allow evacuation of large amounts of unpleasant smells, smoke, various fumes and moisture. By bringing in the fresh air, the device quickly establishes ecological balance of the air volume of a room. They are not intended for use in work environments and housing facilities where air temperature exceeds 40°C.

The ventilators are with modern design and very silent operation. Their installation is very simple. Its installation is very simple and quick. The ventilator body, mask and blades are made of quality plastic.

The ventilator motor has a thermal equipment (insulation class B) which prevents motor overheating.

TEHNIČKE KARAKTERISTIKE:

Ventilator se priključuje na električnu mrežu (električnu struju) od 230V AC i frekvencije od 50Hz.

Prema vrsti zaštite od strujnog udara, ventilator pripada uređajima klase II (230V / 50Hz).

Ventilator je namenjen za eksploataciju na temperaturi vazduha u prostoriji u opsegu od +1°C do +40°C.

Nivo buke na rastojanju od 3m ne prelazi 39dB(A).

TECHNICAL CHARACTERISTICS:

The ventilator is connected to electric power network (electric current) of AC voltage of 230V and 50Hz frequency.

When it comes to electric shock protection, the ventilator belongs to Class II (230V / 50Hz).

The ventilator is intended for exploitation in air temperatures in the range from +1°C to +40°C.

Noise level on 3m distance does not exceed 39dB(A).

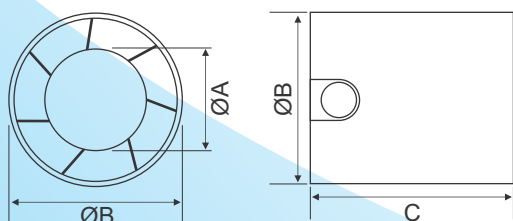

Dimenzije (mm) / Dimensions (mm)

TIP / TYPE	ØA	ØB	C
MTG A100CS	65	97	92
MTG A120CS	65	118	96



**GARANCIJA
WARRANTY 5 GODINA
5 YEARS**



MTG A100CS - Ø100

Šifra Code	Model / Model	Opis modela Model description	Pak. Pack.	Bar kod EAN code
4566A	MTG A100CS	standard / standard	12	8 605009 111379

napon 230V voltage	snaga 15W power	zaštita IP-X4 protection	brzina 2500 ob/min. rpm speed	protok vazduha 98 m ³ /h air flow	nivo buke 37 dB(A) noise level	masa 0,41 kg mass
---------------------------------	------------------------------	---------------------------------------	---	---	---	--------------------------------



**GARANCIJA
WARRANTY 5 GODINA
5 YEARS**



MTG A120CS - Ø120

Šifra Code	Model / Model	Opis modela Model description	Pak. Pack.	Bar kod EAN code
4613A	MTG A120CS	standard / standard	12	8 605009 111386

napon 230V voltage	snaga 20W power	zaštita IP-X4 protection	brzina 2450 ob/min. rpm speed	protok vazduha 190 m ³ /h air flow	nivo buke 39 dB(A) noise level	masa 0,6 kg mass
---------------------------------	------------------------------	---------------------------------------	---	--	---	-------------------------------

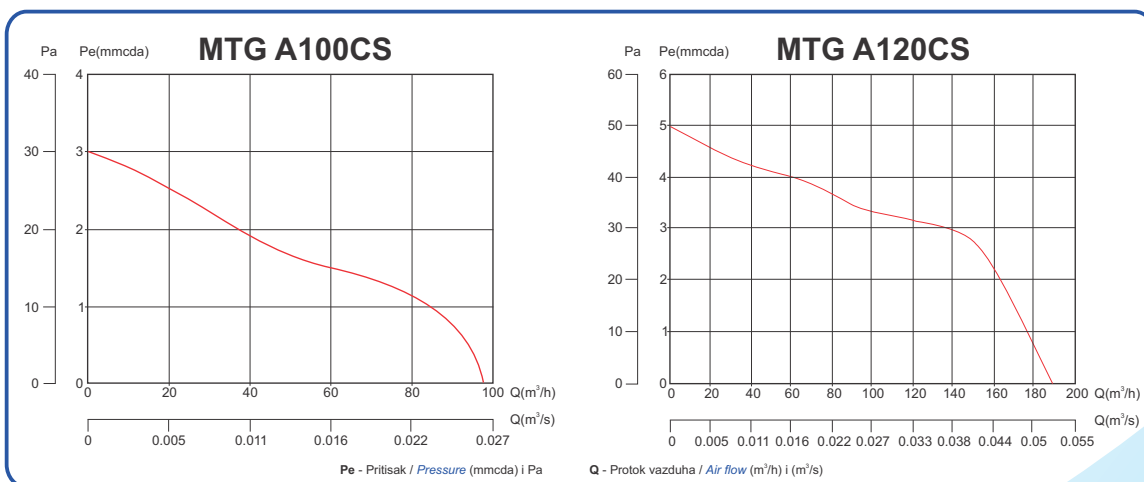

230V / 50Hz; Klasa II / Class II



Motor sa termičkom zaštitom (sa ležajem)
Motor with thermal protection (with bearing)

Mogućnost instalacije / Installation:

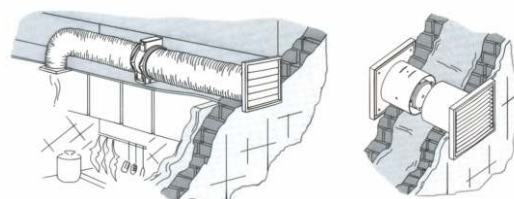

MTG A100AK / A150AK



VENTILATOR SA AUTOMATSKOM KLAPNOM / *VENTILATOR WITH AUTOMATIC FLAP*



NAMENA VENTILATORA

Ventilatori su dizajnirani za ventilaciju stambenog ili poslovnog prostora.

Upotrebljavaju se u prostorijama i na mestima gde je potrebno sprečiti širenje vlage i neprijatnih mirisa.

Nisu namenjeni za upotrebu u radnim okruženjima i stambenim prostorijama gde temperatura vazduha prelazi 40°C.

Ventilator poseduje klapnu na prednjoj strani koja se automatski otvara nakon puštanja aspiratora u rad i sklapa nakon njegovog gašenja. Time se sprečava ulazak stranih tela u prostoriju, dima i neprijatnih mirisa dok ventilator nije u funkciji.

Zbog takve konstrukcije nije potrebno stavljati dodatnu klapnu na zadnju stranu ventilatora!

Njihova ugradnja je vrlo jednostavna i brza. Telo ventilatora, maska i lopatice elise su izrađeni od kvalitetne plastike.

Motor ventilatora opremljen je termičkom zaštitom (B klasa izolacije) koja sprečava dalji rad motora usled njegovog pregrevanja.

PURPOSE OF THE VENTILATOR

The ventilators are designed to ventilate housing or office spaces.

They are used in premises and in places where spreading of humidity and odours needs to be prevented.

They are not intended for use in work environments and housing facilities where air temperature exceeds 40°C.

There is a flap on the front side which is automatically opening when ventilator is turned ON, and automatically closing when ventilator is turned OFF. Because of this front side flap construction it is not necessary to assemble additional back side flap!

Its installation is very simple and quick.

The ventilator body, mask and blades are made of quality plastic.

The ventilator motor has a thermal equipment (insulation class B) which prevents motor overheating.

TEHNIČKE KARAKTERISTIKE:

Ventilator se priključuje na električnu mrežu (električnu struju) od 230V AC i frekvencije od 50Hz.

Prema vrsti zaštite od strujnog udara, ventilator pripada uređajima klase II (230V / 50Hz).

Ventilator je namenjen za eksploataciju na temperaturi vazduha u prostoriji u opsegu od +1°C do +40°C.

Nivo buke na rastojanju od 3m ne prelazi 45dB(A).

TECHNICAL CHARACTERISTICS:

The ventilator is connected to electric power network

(electric current) of AC voltage of 230V and 50Hz frequency.

When it comes to electric shock protection, the ventilator belongs to Class II (230V / 50Hz).

The ventilator is intended for exploitation in air temperatures in the range from +1°C to +40°C.

Noise level on 3m distance does not exceed 45dB(A).

MODELI / MODELS:

T - TAJMER+KLAPNA / *TIMER+FLAP*

H - HIGRO-TAJMER+KLAPNA / *HYGROTIMER+FLAP*

PP - POTEZNI PREKIDAČ / *PULL SWITCH*

K - KLAPNA / *FLAP*

PPK - POTEZNI PREKIDAČ+KLAPNA / *PULL SWITCH+FLAP*

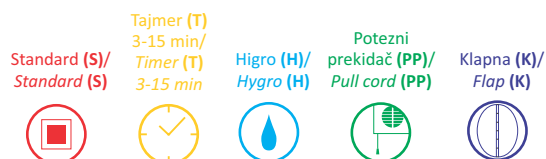

MTG A100AK - Ø100

Šifra Code	Model / Model	Opis modela Model description	Pak. Pack.	Bar kod EAN code
15244	MTG A100AK	standard / <i>standard</i>	12	8 605009 101929
15245	MTG A100AK-T	tajmer / <i>timer</i>	12	8 605009 101936
15246	MTG A100AK-PP	potezni prekidač / <i>pull switch</i>	12	8 605009 101943

napon 230V voltage	snaga 18W power	zaštita IP-X4 protection	brzina 2500 ob/min. rpm speed	protok vazduha 98 m ³ /h air flow	nivo buke 41 dB(A) noise level	masa 0,59 kg mass
---------------------------------	------------------------------	---------------------------------------	--	---	--	-----------------------------------

MTG A150AK - Ø150

Šifra Code	Model / Model	Opis modela Model description	Pak. Pack.	Bar kod EAN code
15248	MTG A150AK	standard / <i>standard</i>	6	8 605009 101967
15249	MTG A150AK-T	tajmer / <i>timer</i>	6	8 605009 101974
17860	MTG A150AK-H	higro-tajmer / <i>hygro-timer</i>	6	8 605009 102001
15250	MTG A150AK-PP	potezni prekidač / <i>pull switch</i>	6	8 605009 101981

napon 230V voltage	snaga 26W power	zaštita IP-X4 protection	brzina 2850 ob/min. rpm speed	protok vazduha 320 m ³ /h air flow	nivo buke 45 dB(A) noise level	masa 0,90 kg mass
---------------------------------	------------------------------	---------------------------------------	--	--	--	-----------------------------------

MTG A100AK / A150AK



VENTILATOR SA AUTOMATSKOM KLAPNOM / *VENTILATOR WITH AUTOMATIC FLAP*



230V / 50Hz
Klasa II / *Class II*

Motor sa termičkom zaštitom
Motor with thermal protection

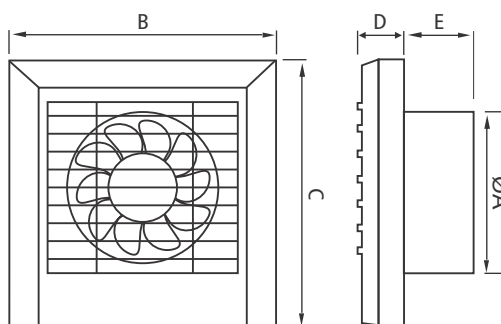

Dimenzije (mm) / *Dimensions (mm)*

TIP / <i>TYPE</i>	ØA	B	C	D	E
MTG A100AK	98	158	167	42	48
MTG A150AK	148	203	234	51	59

Mogućnost instalacije / *Installation:*

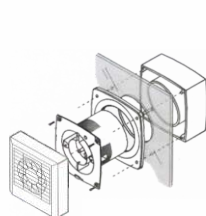

Na Prozor / *On window*

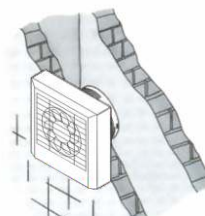

Montaža na zid / *On wall*



NAMENA VENTILATORA

Višenamenski metalni zidni ventilatori su dizajnirani za ventilaciju stambenog, poslovnog i radnog prostora. Upotrebljavaju se u prostorijama i na mestima gde je potrebno da se spreči širenje vlage i neprijatnih mirisa. Nalaze primenu u potisnim i usisnim sistemima, gde se, po zahtevu projekta, zahteva efikasno provetranje. Nisu namenjeni za upotrebu u radnim okruženjima i stambenim prostorijama gde temperatura vazduha prelazi 50°C. Uređaj je usklađen sa svim standardima u vezi sa elektromagnetnim poljima (EMF). Tehničko rešenje proizvoda omogućava dug vek trajanja i pouzdan rad. Prilikom upotrebe potrebno je znati da ventilator nema ugrađen zaštitni filter koji sprečava pristup masnoće na elektro motor. Elisa je zaštićena metalnom mrežicom.

PURPOSE OF THE VENTILATOR

Multi-purpose metal wall ventilators are designed to ventilate housing, working or office spaces. They are used in premises and in places where spreading of humidity and odours needs to be prevented. They are used in blowing and sucking systems where efficient airing is required by projects. They are not intended for use in work environments and housing facilities where air temperature exceeds 50°C. The appliance complies with all electromagnetic field (EMF) standards. The technical design of the product facilitates long life and reliable work. It should be known before use that the ventilator does not have a built-in filter that prevents grease getting in contact with electric motor. The propeller is protected with a metal mesh.

TEHNIČKE KARAKTERISTIKE:

Ventilator se priključuje na električnu mrežu (električnu struju) radnog napona 230V i frekvencije od 50Hz. Prema vrsti zaštite od strujnog udara, ventilator pripada uređajima klase II (230V / 50Hz). Ventilator je namenjen za eksploataciju na temperaturi vazduha u prostoriji u opsegu od -30°C do +50°C. Nivo buke na rastojanju od 3m kreće se u rasponu od 51 do 58dB(A) (u zavisnosti od modela, odnosno prečnika ventilatora). Stepen zaštite elektro motora je IP42.

TECHNICAL CHARACTERISTICS:

Ventilator is connected to electric power network (electric current) with the operating voltage of 230V and frequency of 50Hz. Per type of protection of electric shock, the ventilator belongs in class II (230V / 50Hz). The ventilator is intended for exploitation on the temperature of ambience air in the range from -30°C to +50°C. Noise level on the distance of 3m is within the range of 51 to 58dB(A) (depending on the model that is the diameter of the ventilator). The degree of protection of electric motor is IP42.

Smer vazduha
Air direction

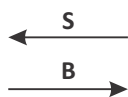

S - Ubacivanje vazduha / Air sucking
B - Izbacivanje vazduha / Air blowing

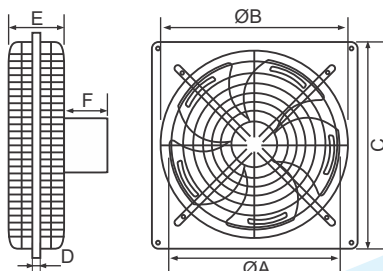

Dimenzije (mm) / Dimensions (mm)



ØA	ØB	C	D	E	F
200	257	257	6	70	53
250	313	313	8	70	60
300	350	350	10	86	80
300	350	350	10	86	80

VIŠENAMENSKI VENTILATOR SA MREŽICAMA



MULTIFUNCTIONAL VENTILATOR WITH GRID





S - Modeli / *Models* (ubacivanje vazduha / *air sucking*)

Šifra <i>Code</i>	Model / <i>Model</i>	Pak. <i>Pack.</i>	Bar kod <i>EAN code</i>
902	MF200G-10		 8 605009 100014



napon	snaga	brzina	protok vazduha	nivo buke	masa
230V	10W	1300 ob/min. rpm	410 m ³ /h	51 dB(A)	1,88 kg
<i>voltage</i>	<i>power</i>	<i>speed</i>	<i>air flow</i>	<i>noise level</i>	<i>mass</i>

Šifra <i>Code</i>	Model / <i>Model</i>	Pak. <i>Pack.</i>	Bar kod <i>EAN code</i>
900	MF250G-16		 8 605009 100021

napon	snaga	brzina	protok vazduha	nivo buke	masa
230V	16W	1300 ob/min. rpm	800 m ³ /h	53 dB(A)	2,48 kg
<i>voltage</i>	<i>power</i>	<i>speed</i>	<i>air flow</i>	<i>noise level</i>	<i>mass</i>



Šifra <i>Code</i>	Model / <i>Model</i>	Pak. <i>Pack.</i>	Bar kod <i>EAN code</i>
901	MF300G-25		 8 605009 100038

napon	snaga	brzina	protok vazduha	nivo buke	masa
230V	25W	1300 ob/min. rpm	1220 m ³ /h	58 dB(A)	3,54 kg
<i>voltage</i>	<i>power</i>	<i>speed</i>	<i>air flow</i>	<i>noise level</i>	<i>mass</i>



Šifra <i>Code</i>	Model / <i>Model</i>	Pak. <i>Pack.</i>	Bar kod <i>EAN code</i>
857	MF300G-34		 8 605009 100045

napon	snaga	brzina	protok vazduha	nivo buke	masa
230V	34W	1300 ob/min. rpm	1400 m ³ /h	58 dB(A)	3,68 kg
<i>voltage</i>	<i>power</i>	<i>speed</i>	<i>air flow</i>	<i>noise level</i>	<i>mass</i>



B - Modeli / *Models* (izbacivanje vazduha / *air blowing*)

Šifra <i>Code</i>	Model / <i>Model</i>	Pak. <i>Pack.</i>	Bar kod <i>EAN code</i>
22435	MF200G-10		 8 605009 113731



napon	snaga	brzina	protok vazduha	nivo buke	masa
230V	10W	1300 ob/min. rpm	410 m ³ /h	51 dB(A)	1,88 kg
<i>voltage</i>	<i>power</i>	<i>speed</i>	<i>air flow</i>	<i>noise level</i>	<i>mass</i>

Šifra <i>Code</i>	Model / <i>Model</i>	Pak. <i>Pack.</i>	Bar kod <i>EAN code</i>
22436	MF250G-16		 8 605009 113748

napon	snaga	brzina	protok vazduha	nivo buke	masa
230V	16W	1300 ob/min. rpm	800 m ³ /h	53 dB(A)	2,48 kg
<i>voltage</i>	<i>power</i>	<i>speed</i>	<i>air flow</i>	<i>noise level</i>	<i>mass</i>

Šifra <i>Code</i>	Model / <i>Model</i>	Pak. <i>Pack.</i>	Bar kod <i>EAN code</i>
22437	MF300G-25		 8 605009 113755

napon	snaga	brzina	protok vazduha	nivo buke	masa
230V	25W	1300 ob/min. rpm	1220 m ³ /h	58 dB(A)	3,54 kg
<i>voltage</i>	<i>power</i>	<i>speed</i>	<i>air flow</i>	<i>noise level</i>	<i>mass</i>

Šifra <i>Code</i>	Model / <i>Model</i>	Pak. <i>Pack.</i>	Bar kod <i>EAN code</i>
22438	MF300G-34		 8 605009 113762

napon	snaga	brzina	protok vazduha	nivo buke	masa
230V	34W	1300 ob/min. rpm	1400 m ³ /h	58 dB(A)	3,68 kg
<i>voltage</i>	<i>power</i>	<i>speed</i>	<i>air flow</i>	<i>noise level</i>	<i>mass</i>



NAMENA VENTILATORA

Višenamenski metalni zidni ventilatori su dizajnirani za ventilaciju stambenog, poslovnog i radnog prostora. Upotrebljavaju se u prostorijama i na mestima gde je potrebno da se spreči širenje vlage i neprijatnih mirisa. Nalaze primenu u potisnim i usisnim sistemima, gde se, po zahtevu projekta, zahteva efikasno provetranje. Nisu namenjeni za upotrebu u radnim okruženjima i stambenim prostorijama gde temperatura vazduha prelazi 50°C. Uređaj je usklađen sa svim standardima u vezi sa elektromagnetnim poljima (EMF). Tehničko rešenje proizvoda omogućava dug vek trajanja i pouzdan rad. Prilikom upotrebe potrebno je znati da ventilator nema ugrađen zaštitni filter koji sprečava pristup masnoće na elektro motor. Elisa je zaštićena metalnom mrežicom.

PURPOSE OF THE VENTILATOR

Multi-purpose metal wall ventilators are designed to ventilate housing, working or office spaces. They are used in premises and in places where spreading of humidity and odours needs to be prevented. They are used in blowing and sucking systems where efficient airing is required by projects. They are not intended for use in work environments and housing facilities where air temperature exceeds 50°C. The appliance complies with all electromagnetic field (EMF) standards.

The technical design of the product facilitates long life and reliable work. It should be known before use that the ventilator does not have a built-in filter that prevents grease getting in contact with electric motor. The propeller is protected with a metal mesh.

TEHNIČKE KARAKTERISTIKE:

Ventilator se priključuje na električnu mrežu (električnu struju) radnog napona 230V i frekvencije od 50Hz. Prema vrsti zaštite od strujnog udara, ventilator pripada uređajima klase II (230V / 50Hz). Ventilator je namenjen za eksploataciju na temperaturi vazduha u prostoriji u opsegu od -30°C do +50°C. Nivo buke na rastojanju od 3m kreće se u rasponu od 53 do 60dB(A) (u zavisnosti od modela, odnosno prečnika ventilatora). Stepen zaštite elektro motora je IP42.

TECHNICAL CHARACTERISTICS:

Ventilator is connected to electric power network (electric current) with the operating voltage of 230V and frequency of 50Hz. Per type of protection of electric shock, the ventilator belongs in class II (230V / 50Hz). The ventilator is intended for exploitation on the temperature of ambience air in the range from -30°C to +50°C. Noise level on the distance of 3m is within the range of 53 to 60dB(A) (depending on the model that is the diameter of the ventilator). The degree of protection of electric motor is IP42.

Smer vazduha
Air direction

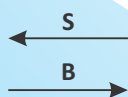

S - Ubacivanje vazduha / Air sucking

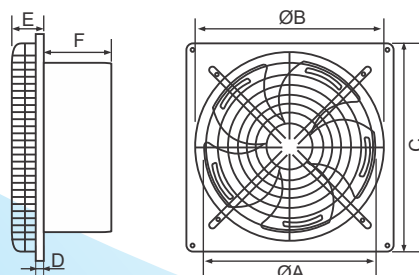

B - Izbacivanje vazduha / Air blowing





Dimenzije (mm) / Dimensions (mm)

ØA	ØB	C	D	E	F
200	220	264	11	18	127
250	270	314	11	18	147
300	320	364	11	18	155
300	320	364	11	18	155



S - Modeli / *Models* (ubacivanje vazduha / *air sucking*)

Šifra <i>Code</i>	Model / <i>Model</i>	Pak. <i>Pack.</i>	Bar kod <i>EAN code</i>
20784	MF200Z-10		 8 605009 113779



napon 230V <i>voltage</i>	snaga 10W <i>power</i>	brzina 1300 ob/min. rpm <i>speed</i>	protok vazduha 410 m ³ /h <i>air flow</i>	nivo buke 53 dB(A) <i>noise level</i>	masa 2,35 kg <i>mass</i>
--	-------------------------------------	---	---	---	--

Šifra <i>Code</i>	Model / <i>Model</i>	Pak. <i>Pack.</i>	Bar kod <i>EAN code</i>
20785	MF250Z-16		 8 605009 113786

napon 230V <i>voltage</i>	snaga 16W <i>power</i>	brzina 1300 ob/min. rpm <i>speed</i>	protok vazduha 800 m ³ /h <i>air flow</i>	nivo buke 56 dB(A) <i>noise level</i>	masa 2,83 kg <i>mass</i>
--	-------------------------------------	---	---	---	--



Šifra <i>Code</i>	Model / <i>Model</i>	Pak. <i>Pack.</i>	Bar kod <i>EAN code</i>
20786	MF300Z-25		 8 605009 113793

napon 230V <i>voltage</i>	snaga 25W <i>power</i>	brzina 1300 ob/min. rpm <i>speed</i>	protok vazduha 1220 m ³ /h <i>air flow</i>	nivo buke 60 dB(A) <i>noise level</i>	masa 3,54 kg <i>mass</i>
--	-------------------------------------	---	--	---	--



Šifra <i>Code</i>	Model / <i>Model</i>	Pak. <i>Pack.</i>	Bar kod <i>EAN code</i>
21593	MF300Z-34		 8 605009 113809

napon 230V <i>voltage</i>	snaga 34W <i>power</i>	brzina 1300 ob/min. rpm <i>speed</i>	protok vazduha 1400 m ³ /h <i>air flow</i>	nivo buke 60 dB(A) <i>noise level</i>	masa 3,68 kg <i>mass</i>
--	-------------------------------------	---	--	---	--



B - Modeli / Models (izbacivanje vazduha / air blowing)

Šifra Code	Model / Model	Pak. Pack.	Bar kod EAN code
22439	MF200Z-10		 8 605009 1113816



napon	snaga	brzina	protok vazduha	nivo buke	masa
230V	10W	1300 ob/min. rpm	410 m ³ /h	53 dB(A)	2,35 kg
voltage	power	speed	air flow	noise level	mass

Šifra Code	Model / Model	Pak. Pack.	Bar kod EAN code
22440	MF250Z-16		 8 605009 1113823

napon	snaga	brzina	protok vazduha	nivo buke	masa
230V	16W	1300 ob/min. rpm	800 m ³ /h	56 dB(A)	2,83 kg
voltage	power	speed	air flow	noise level	mass

Šifra Code	Model / Model	Pak. Pack.	Bar kod EAN code
22441	MF300Z-25		 8 605009 1113830

napon	snaga	brzina	protok vazduha	nivo buke	masa
230V	25W	1300 ob/min. rpm	1220 m ³ /h	60 dB(A)	3,54 kg
voltage	power	speed	air flow	noise level	mass

Šifra Code	Model / Model	Pak. Pack.	Bar kod EAN code
22442	MF300Z-34		 8 605009 1113847

napon	snaga	brzina	protok vazduha	nivo buke	masa
230V	34W	1300 ob/min. rpm	1400 m ³ /h	60 dB(A)	3,68 kg
voltage	power	speed	air flow	noise level	mass



NAMENA VENTILATORA

Višenamenski metalni cevni ventilatori su dizajnirani za ventilaciju stambenog, poslovnog i radnog prostora. Upotrebljavaju se u prostorijama i na mestima gde je potrebno da se spreči širenje vlage i neprijatnih mirisa. Nalaze primenu u potisnim i usisnim sistemima, gde se, po zahtevu projekta, zahteva efikasno provetranje. Nisu namenjeni za upotrebu u radnim okruženjima i stambenim prostorijama gde temperatura vazduha prelazi 50°C. Uređaj je usklađen sa svim standardima u vezi sa elektromagnetnim poljima (EMF). Tehničko rešenje proizvoda omogućava dug vek trajanja i pouzdan rad. Prilikom upotrebe potrebno je znati da ventilator nema ugrađen zaštitni filter koji sprečava pristup masnoće na elektro motor. Elisa je zaštićena metalnom mrežicom.

PURPOSE OF THE VENTILATOR

Multi-purpose metal pipe ventilators are designed to ventilate housing, working or office spaces. They are used in premises and in places where spreading of humidity and odours needs to be prevented. They are used in blowing and sucking systems where efficient airing is required by projects. They are not intended for use in work environments and housing facilities where air temperature exceeds 50°C. The appliance complies with all electromagnetic field (EMF) standards.

The technical design of the product facilitates long life and reliable work. It should be known before use that the ventilator does not have a built-in filter that prevents grease getting in contact with electric motor. The propeller is protected with a metal mesh.

TEHNIČKE KARAKTERISTIKE:

Ventilator se priključuje na električnu mrežu (električnu struju) radnog napona 230V i frekvencije od 50Hz. Prema vrsti zaštite od strujnog udara, ventilator pripada uređajima klase II (230V / 50Hz). Ventilator je namenjen za eksploataciju na temperaturi vazduha u prostoriji u opsegu od -30°C do ~+50°C. Nivo buke na rastojanju od 3m kreće se u rasponu od 55 do 62dB(A) (u zavisnosti od modela, odnosno prečnika ventilatora). Stepen zaštite elektro motora je IP42.

TECHNICAL CHARACTERISTICS:

Ventilator is connected to electric power network (electric current) with the operating voltage of 230V and frequency of 50Hz. Per type of protection of electric shock, the ventilator belongs in class II (230V / 50Hz). The ventilator is intended for exploitation on the temperature of ambience air in the range from -30°C to +50°C. Noise level on the distance of 3m is within the range of 55 to 62dB(A) (depending on the model that is the diameter of the ventilator). The degree of protection of electric motor is IP42.

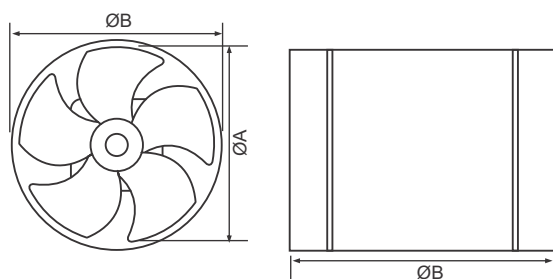



Dimenzije (mm) /
Dimensions (mm)

ØA	ØB	C
200	220	250
250	270	250
300	320	250
300	320	250



VIŠENAMENSKI METALNI VENTILATOR CEVNI

MULTIFUNCTIONAL METAL PIPE VENTILATOR





Šifra Code	Model / Model	Pak. Pack.	Bar kod EAN code
20781	MF200C-10		 8 605009 113854



napon 230V voltage	snaga 10W power	brzina 1300 ob/min. rpm speed	protok vazduha 410 m ³ /h air flow	nivo buke 55 dB(A) noise level	masa 2,40 kg mass
---------------------------------	------------------------------	--	--	--	-----------------------------------

Šifra Code	Model / Model	Pak. Pack.	Bar kod EAN code
20782	MF250C-16		 8 605009 113861

napon 230V voltage	snaga 16W power	brzina 1300 ob/min. rpm speed	protok vazduha 800 m ³ /h air flow	nivo buke 57 dB(A) noise level	masa 2,98 kg mass
---------------------------------	------------------------------	--	--	--	-----------------------------------

Šifra Code	Model / Model	Pak. Pack.	Bar kod EAN code
20783	MF300C-25		 8 605009 113878

napon 230V voltage	snaga 25W power	brzina 1300 ob/min. rpm speed	protok vazduha 1220 m ³ /h air flow	nivo buke 60 dB(A) noise level	masa 3,54 kg mass
---------------------------------	------------------------------	--	---	--	-----------------------------------

Šifra Code	Model / Model	Pak. Pack.	Bar kod EAN code
21594	MF300C-34		 8 605009 113885

napon 230V voltage	snaga 34W power	brzina 1300 ob/min. rpm speed	protok vazduha 1400 m ³ /h air flow	nivo buke 62 dB(A) noise level	masa 3,68 kg mass
---------------------------------	------------------------------	--	---	--	-----------------------------------



VENTILACIONA REŠETKA - 1 red podesivih lamela / *VENTILATION GRILLE - 1 raw of adjustable horizontal blades*

Rešetka sa jednim redom podesivih horizontalnih lamela bez regulatora protoka vazduha.

Ova rešetka se koristi za odvođenje ili dovođenje vazduha u raznim ventilacionim sistemima. Izrađena je od eloksiranog aluminijuma, a na zahtev kupca može biti izrađena i u drugoj boji. Dostupna je u svim dimenzijama dole prikazanim, a postoji mogućnost izrade i u svim drugim dimenzijama prema zahtevu kupca.

Grille with one raw of adjustable horizontal blades, without damper. This grillis is used for ventilation in diferent ventilation systems. It is made of anodized aluminium and can be made in other colours according customers requests.

Available in all dimensions shown below and can be made in other dimensions according customers requests.

Dimenzije predstavljaju mere štucne / *Hole dimensions*

Širina / *Width* (mm) - **B:** 100, 150, 200, 225, 250, 300, 350, 400, 425, 450, 500

Visina / *Height* (mm) - **H:** 100, 150, 200, 225, 250, 300, 350, 400, 425, 450, 500



VENTILACIONA REŠETKA - 2 reda podesivih lamela / *VENTILATION GRILLE - 2 raws of adjustable horizontal blades*

Rešetka sa dva reda podesivih horizontalnih / vertikalnih lamela bez regulatora protoka vazduha.

Ova rešetka se koristi za odvođenje ili dovođenje vazduha u raznim ventilacionim sistemima. Izrađena je od eloksiranog aluminijuma, a na zahtev kupca može biti izrađena i u drugoj boji. Dostupna je u svim dimenzijama dole prikazanim, a postoji mogućnost izrade i u svim drugim dimenzijama prema zahtevu kupca.

Grille with two raws of adjustable horizontal / vertical blades, without damper. This grillis is used for ventilation in diferent ventilation systems. It is made of anodized aluminium and can be made in other colours according customers requests.

Available in all dimensions shown below and can be made in other dimensions according customers requests.

Dimenzije predstavljaju mere štucne / *Hole dimensions*

Širina / *Width* (mm) - **B:** 100, 150, 200, 225, 250, 300, 350, 400, 425, 450, 500

Visina / *Height* (mm) - **H:** 100, 150, 200, 225, 250, 300, 350, 400, 425, 450, 500

VENTILACIONE REŠETKE ALUMINIJUMSKE

ALUMINIUM VENTILATION GRILLES



VENTILACIONA REŠETKA - 1 red podesivih lamela i regulator protoka vazduha

VENTILATION GRILLE - 1 raw of adjustable horizontal blades with parallel blade damper

Rešetka sa jednim redom podesivih horizontalnih lamela sa regulatorom protoka vazduha.

Ova rešetka se koristi za odvođenje ili dovođenje vazduha u raznim ventilacionim sistemima. Izrađena je od eloksiranog aluminijuma, a na zahtev kupca može biti izrađena i u drugoj boji. Dostupna je u svim dimenzijama dole prikazanim, a postoji mogućnost izrade i u svim drugim dimenzijama prema zahtevu kupca.

Ova rešetka na sebi ima ugrađen regulator protoka vazduha (DAMPER).

On služi da bi se promenili protok i količina vazduha. Regulacija se vrši ručnim podešavanjem krilaca.

Grille with one raw of adjustable horizontal blades, with parallel blade damper. This grillis is used for ventilation in different ventilation systems. It is made of anodized aluminium and can be made in other colours according customers requests.

Available in all dimensions shown below and can be made in other dimensions according customers requests.

This grill has build in air flow regulator (DAMPER).

It is used for changing flow and amount of air. Grills are manually adjustable.

Dimenzije predstavljaju mere štucne / *Hole dimensions*

Širina / *Width* (mm) - **B:** 100, 150, 200, 225, 250, 300, 350, 400, 425, 450, 500

Visina / *Height* (mm) - **H:** 100, 150, 200, 225, 250, 300, 350, 400, 425, 450, 500



VENTILACIONA REŠETKA - 2 reda podesivih lamela i regulator protoka vazduha

VENTILATION GRILLE - 2 raws of adjustable horizontal blades with parallel blade damper

Rešetka sa dva reda podesivih horizontalnih / vertikalnih lamela sa regulatorom protoka vazduha.

Ova rešetka se koristi za odvođenje ili dovođenje vazduha u raznim ventilacionim sistemima. Izrađena je od eloksiranog aluminijuma, a na zahtev kupca može biti izrađena i u drugoj boji. Dostupna je u svim dimenzijama dole prikazanim, a postoji mogućnost izrade i u svim drugim dimenzijama prema zahtevu kupca.

Ova rešetka na sebi ima ugrađen regulator protoka vazduha (DAMPER).

On služi da bi se promenili protok i količina vazduha. Regulacija se vrši ručnim podešavanjem krilaca.

Grille with two raws of adjustable horizontal / vertical blades, with parallel blade dumper. This grillis is used for ventilation in diferent ventilation systems. It is made of anodized aluminium and can be made in other colours according customers requests.

Available in all dimensions shown below and can be made in other dimensions according customers requests.

This grill has build in air flow regulator (DAMPER).

It is used for changing flow and amount of air. Grills are manually adjustable.

Dimenzije predstavljaju mere štucne / *Hole dimensions*

Širina / *Width* (mm) - **B:** 100, 150, 200, 225, 250, 300, 350, 400, 425, 450, 500

Visina / *Height* (mm) - **H:** 100, 150, 200, 225, 250, 300, 350, 400, 425, 450, 500

VENTILACIONA SAMOPADAJUĆA REŠETKA / *VENTILATION GRAVITY GRILLE*



Samopadajuća rešetka koja se postavlja na zid, sa jednim redom pokretnih lamela za izbacivanje vazduha pod pritiskom. Lamelle su paralelne prvoj pomenutoj dimenziji.

Ova rešetka se koristi za odvođenje ili dovođenje vazduha u raznim ventilacionim sistemima. Izrađena je od eloksanog aluminijuma, a na zahtev kupca može biti izrađena i u drugoj boji. Dostupna je u svim dimenzijama dole prikazanim, a postoji mogućnost izrade i u svim drugim dimenzijama prema zahtevu kupca.

Gravity grille for wall instalation with one row of free moving blades for air exhaust after pressure. The blades are parallel to the first mentioned dimension. This grillis is used for ventilation in diferent ventilation systems. It is made of anodized aluminium and can be made in other colours according customers requests. Available in all dimensions shown below and can be made in other dimensions according customers requests.

Dimenzije predstavljaju mere štucne / *Hole dimensions*

Širina / *Width* (mm) - **B:** 200, 250, 300, 350, 400, 450, 500

Visina / *Height* (mm) - **H:** 125, 200, 250, 300, 350, 400, 450, 500

PROTIVKIŠNA REŠETKA / *LOUVRE*



Protivkišna rešetka sa širokim fiksnim lamelama i zaštitnom mrežom protiv insekata.

Dimenzije otvora (kockica) na mreži su 6x6mm.

Izrađena je od eloksanog aluminijuma, a na zahtev kupca može biti izrađena i u drugoj boji. Dostupna je u svim dimenzijama dole prikazanim, a postoji mogućnost izrade i u svim drugim dimenzijama prema zahtevu kupca.

Louvre with wide curved fixed blades and wire mash with 6x6mm holes. Which is god against diferent kinds of insects.

It is made of anodized aluminium and can be made in other colours according customers requests. Available in all dimensions shown below and can be made in other dimensions according customers requests.

Dimenzije predstavljaju mere štucne / *Hole dimensions*

Širina / *Width* (mm) - **B:** 200, 250, 300, 350, 400, 450, 500

Visina / *Height* (mm) - **H:** 125, 200, 250, 300, 350, 400, 450, 500



PRESTRUJNA REŠETKA ZA VRATA SA "Λ" LAMELAMA ZA CIRKULISANJE VAZDUHA IZMEĐU PROSTORIJA, SA KONTRA RAMOM

DOOR GRILLE EQUIPED WITH "Λ" SHAPED BLADES FOR AIR TRANSFER BETWEEN ROOMS, WITHOUT VISUAL CONTACT, WITH FRAME IN BOTH SIDES



Rešetka "PR" omogućava strujanje vazduha kroz vrata u pregradne zidove u sistemu ventilacije i klimatizacije. Rešetka je pogodna za ugradnju u vrata i zidove, a u posebnim slučajevima (pomoću štucne) i u zidove većih debljina. Rešetka je izrađena od eloksanog aluminijuma u prirodnoj boji, a na poseban zahtev može se izraditi u drugim bojama. Dostupna je u svim dimenzijama dole prikazanim, a postoji mogućnost izrade i u svim drugim dimenzijama prema zahtevu kupca.

Door Grille „PR“ enables air-flow through door in wall chambers in ventilation and air conditioning system. Door Grille is suitable for installing in doors and walls, and in special cases (using by frame) into the more thickness walls. It is made of anodized aluminium in natural colour and can be made in other colours according customers requests.

Available in all dimensions shown below and can be made in other dimensions according customers requests.

Dimenzije predstavljaju mere štucne / *Hole dimensions*

Širina / *Width* (mm) - **B:** 100, 150, 200, 225, 250, 300, 350, 400, 425, 450, 500

Visina / *Height* (mm) - **H:** 100, 150, 200, 225, 250, 300, 350, 400, 425, 450, 500

VENTILATORI - PRATEĆA OPREMA

VENTILATOR ACCESSORIES



Šifra Code	Artikal / Article	Dimenzije Dimensions	Pak. Pack.	Bar kod EAN code
17741	KLAPNA VENTILATORA / <i>VENTILATOR FLAP</i>	Ø100		8 605009 1101554

Šifra Code	Artikal / Article	Dimenzije Dimensions	Pak. Pack.	Bar kod EAN code
17742	KLAPNA VENTILATORA / <i>VENTILATOR FLAP</i>	Ø120		8 605009 1101561



Šifra Code	Artikal / Article	Dimenzije Dimensions	Pak. Pack.	Bar kod EAN code
17854	PRIRUBNICA VENTILATORA / <i>VENTILATOR FLANGE</i>	Ø100		8 605009 1111027

Šifra Code	Artikal / Article	Dimenzije Dimensions	Pak. Pack.	Bar kod EAN code
20836	PRIRUBNICA VENTILATORA / <i>VENTILATOR FLANGE</i>	Ø120		8 605009 1111034



Šifra Code	Artikal / Article	Dimenzije Dimensions	Pak. Pack.	Bar kod EAN code
31539	REDUKCIONI KONEKTOR VENTILATORA <i>REDUCING CONNECTOR OF THE FAN</i>	Ø100 / Ø120	20	8 605009 111105 8

Šifra Code	Artikal / Article	Dimenzije Dimensions	Pak. Pack.	Bar kod EAN code
31540	REDUKCIONI KONEKTOR VENTILATORA <i>REDUCING CONNECTOR OF THE FAN</i>	Ø120 / Ø150	20	8 605009 111106 8



FILTER ASPIRATORA UNIVERZALNI / *UNIVERSAL VENTILATION FILTER*













Šifra Code	Artikal / Article	Dimenzije dimensions	Pak. Pack.	Bar kod EAN code
9581	FILTER ASPIRATORA UNIVERZALNI - POLIESTER / <i>UNIVERSAL VENTILATION FILTER - POLIESTER</i>	560x420mm	60	8 605009 110191 2













PRIKLJUČNI KABLOVI

CONNECTION CABLES

















Šifra Code	Opis / Description	Pak. Pack.	Bar kod EAN code
15555	H05VV-F 3G1,5 / 1,5m / 		 8 605 009 1103114
9192	H05VV-F 3G1,5 / 2m / 		 8 605 009 1103343
9716	H05VV-F 3G1,5 / 3m / 		 8 605 009 1103152
9717	H05VV-F 3G1,5 / 5m / 		 8 605 009 1103169

Šifra Code	Opis / Description	Pak. Pack.	Bar kod EAN code
000894	H05VV-F 3G2,5 / 1,5m / 		 8 605 009 1103381
001074	H05VV-F 3G2,5 / 2m / 		 8 605 009 1103220
000179	H05VV-F 3G2,5 / 3m / 		 8 605 009 1103374
000180	H05VV-F 3G2,5 / 5m / 		 8 605 009 1103398



Šifra Code	Opis / Description	Pak. Pack.	Bar kod EAN code
006236	H05VV-F 5G2,5 / 1,5m / 		 8 605 009 1103213
005272	H05VV-F 5G2,5 / 2m / 		 8 605 009 1103336
11485	H05VV-F 5G2,5 / 3m / 		 8 605 009 1103367
29142	H05VV-F 5G2,5 / 5m / 		 8 605 009 1104401



JEDNOFAZNI UTIKAČ POD UGLOM
SINGLE PHASE ANGLED PLUG



TROFAZNI UTIKAČ POD UGLOM
THREE PHASE ANGLED PLUG



BOJA SAVITLJIVOG KABLA
CABLE COLOUR

PRIKLJUČNI KABLOVI ZA ELEKTRIČNE I RUČNE ALATE / CONNECTION CABLES FOR ELECTRICAL APPLIANCES



Šifra Code	Opis / Description	Pak. Pack.	Bar kod EAN code
30838	H05RR-F 2G1 / 2m / ● 1 x		8 605 009 145336
30839	H05RR-F 2G1 / 4m / ● 1 x		8 605 009 145343
Šifra Code	Opis / Description	Pak. Pack.	Bar kod EAN code
30840	H05RR-F 2G1,5 / 2m / ● 1 x		8 605 009 145350
30841	H05RR-F 2G1,5 / 4m / ● 1 x		8 605 009 145367
Šifra Code	Opis / Description	Pak. Pack.	Bar kod EAN code
30842	H05VV-F 2G1 / 2m / ● 1 x		8 605 009 145374
30843	H05VV-F 2G1 / 4m / ● 1 x		8 605 009 145381
Šifra Code	Opis / Description	Pak. Pack.	Bar kod EAN code
30844	H05VV-F 2G1,5 / 2m / ● 1 x		8 605 009 145398
30845	H05VV-F 2G1,5 / 4m / ● 1 x		8 605 009 145404





Šifra Code	Opis / Description	Pak. Pack.	Bar kod EAN code
22104	H05RR-F 3G1,5 / 1,5m / ● 1 x		 8 605 009 1103091
20015	H05RR-F 3G1,5 / 2m / ● 1 x		 8 605 009 1103107
29536	H05RR-F 3G1,5 / 3m / ● 1 x		 8 605 009 1103558

Šifra Code	Opis / Description	Pak. Pack.	Bar kod EAN code
19556	H05RR-F 3G2,5 / 1,5m / ● 1 x		 8 605 009 1103121
007064	H05RR-F 3G2,5 / 2m / ● 1 x		 8 605 009 1103145
29537	H05RR-F 3G2,5 / 3m / ● 1 x		 8 605 009 1103084











Šifra Code	Opis / Description	Pak. Pack.	Bar kod EAN code
6041	H05RR-F 5G2,5 / 1,5m / ● 1 x		 8 605 009 1103244
5923	H05RR-F 5G2,5 / 2m / ● 1 x		 8 605 009 1103305
5021	H05RR-F 5G2,5 / 3m / ● 1 x		 8 605 009 1103138



















KABL PEGLE / IRON CABLE



Šifra Code	Opis / Description	Pak. Pack.	Bar kod EAN code
467	H05RR-F 3G0,75 / 2m /  1 x 		 8 605009 104081
758	H05RR-F 3G0,75 / 3m /  1 x 		 8 605009 104098





TELEFONSKI KABL / TELEPHONE CABLE



Šifra Code	Opis / Description	Pak. Pack.	Bar kod EAN code
000295	PGA4 / 3m /  2 x 		 8 605009 103596
000466	PGA4 / 5m /  2 x 		 8 605009 103602
000296	PGA4 / 10m /  2 x 		 8 605009 103619
000297	PGA4 / 15m /  2 x 		 8 605009 103626

TELEFONSKI KABL SPIRALNI / TELEPHONE SPIRAL CABLE



Šifra Code	Opis / Description	Pak. Pack.	Bar kod EAN code
21970	PGA4 / 3m /  2 x 		 8 605009 103299



JEDNOFAZNI UTIKAČ POD UGLOM
SINGLE PHASE ANGLED PLUG



TELEFONSKI KONEKTOR MUŠKI
TELEPHONE CONNECTOR MALE



ANTENSKI KONEKTOR MUŠKI
ANTENNA CONNECTOR MALE











ANTENSKI KONEKTOR ŽENSKI
ANTENNA CONNECTOR FEMALE











BOJA SAVITLJIVOG KABLA
CABLE COLOUR

PRIKLJUČNI KABL SA MEĐUGAJTANSKIM PREKIDAČEM / CONNECTION CABLE WITH SWITCH







Šifra Code	Opis / Description	Pak. Pack.	Bar kod EAN code
11412	H03VV-F 2G0,50 / 2m / ○ 1 x  / 1 x 		 8 605009 1103268
25928	H03VV-F 2G0,50 / 3m / ○ 1 x  / 1 x 		 8 605009 1103275







Šifra Code	Opis / Description	Pak. Pack.	Bar kod EAN code
004037	H03VV-F 2G0,50 / 2m / ● 1 x  / 1 x 		 8 605009 1127226
31673	H03VV-F 2G0,50 / 3m / ● 1 x  / 1 x 		 8 605009 1103688

PRIKLJUČNI KABL SA MEĐUGAJTANSKIM DIMEROM / CONNECTION CABLE WITH DIMMABLE SWITCH



Šifra Code	Opis / Description	Pak. Pack.	Bar kod EAN code
004039	H03VV-F 2G0,50 / 3m / ○ 1 x  / 1 x 		 8 605009 1127233



Šifra Code	Opis / Description	Pak. Pack.	Bar kod EAN code
004040	H03VV-F 2G0,50 / 3m / ● 1 x  / 1 x 		 8 605009 1127240



KABL ANTENE / ANTENNA CABLE



Šifra Code	Opis / Description	Pak. Pack.	Bar kod EAN code
9693	RG6 / 2m / / 1 x / 1 x		8 605009 1103923
9694	RG6 / 3m / / 1 x / 1 x		8 605009 1103930
9695	RG6 / 5m / / 1 x / 1 x		8 605009 1103947

ADAPTERI SA KABLOM / ADAPTERS WITH CABLE



Šifra Code	Opis / Description	Pak. Pack.	Bar kod EAN code
29814	H05RR-F 5G2,50 / 0,5m / 1 x / 1 x 16A, 250V/50Hz		8 605009 1126861



Šifra Code	Opis / Description	Pak. Pack.	Bar kod EAN code
29815	H05RR-F 5G2,50 / 0,5m / 1 x / 1 x 16A, 250V/50Hz		8 605009 1126861

* **MOGUĆNOST IZRADE ADAPTERA SA VEĆOM DUŽINOM SAVITLJIVOG KABLA**
 * **THE POSSIBILITY OF MAKING ADAPTER WITH A LONGER LENGTH OF FLEXIBLE CABLE**

** **MOGUĆNOST IZRADE PRODUŽNOG KABLA SA INDUSTRIJSKIM UTIKAČEM I PRIKLJUČNICOM**

** **THE POSSIBILITY OF MAKING EXTENSION CORD WITH INDUSTRIAL PLUG AND SOCKET (CEE NORM)**



EURO UTIKAČ
EURO PLUG



TELEFONSKI KONEKTOR MUŠKI
TELEPHONE CONNECTOR MALE



TROFAZNI UTIKAČ POD UGLOM
THREE PHASE ANGLED PLUG



CEE RAVNA PRIKLJUČNICA
CEE STRAIGHT SOCKET



CEE RAVAN UTIKAČ
CEE STRAIGHT PLUG



TROFAZNA PRIKLJUČNICA
THREE PHASE SOCKET



BOJA SAVITLJIVOG KABLA
CABLE COLOUR







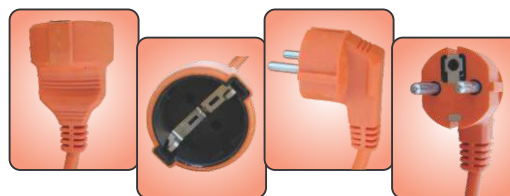







JEDNOSTRUKÉ PRENOSNE PRIKLJUČNICE
SINGLE PORTABLE SOCKETS-OUTLETS

JEDNOSTRUKÉ PRENOSNE PRIKLJUČNICE SINGLE PORTABLE SOCKETS-OUTLETS





PRENOSNA PRIKLJUČNICA NERASTAVNA / SINGLE PORTABLE SOCKET OUTLET
JEDNOSTRUKA SA SAVITLJIVIM KABLOM I NOSAČEM / UNWIREABLE WITH CABLE AND CARRIER

Šifra Code	Opis / Description	Pak. Pack.	Bar kod EAN code
22893	H05VV-F 3G1,5 / 15m / ● 1 x  / 1 x 		 8 605009 119917
22040	H05VV-F 3G1,5 / 20m / ● 1 x  / 1 x 		 8 605009 104944
22896	H05VV-F 3G1,5 / 30m / ● 1 x  / 1 x 		 8 605009 119924

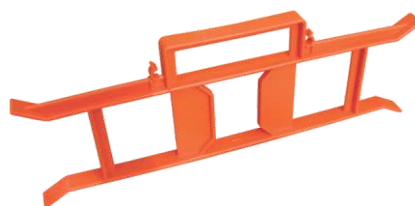
NOSAČ KABLA / CABLE CARRIER



Šifra Code	Artikal / Article	Pak. Pack.	Bar kod EAN code
22105	NOSAČ KABLA ORANŽ / CABLE CARRIER ORANGE		 8 605009 1103725



JEDNOFAZNA PRIKLJUČNICA RAVNA
SINGLE PHASE STRAIGHT SOCKET



JEDNOFAZNI UTIKAČ POD UGLOM
SINGLE PHASE ANGLED PLUG



BOJA SAVITLJIVOG KABLA / CABLE COLOUR

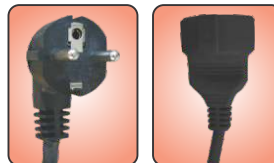

PRENOSNA PRIKLJUČNICA NERASTAVNA / SINGLE PORTABLE SOCKET OUTLET
 JEDNOSTRUKA SA SAVITLJIVIM KABLOM I NOSAČEM / UNWIREABLE WITH CABLE AND CARRIER

Šifra Code	Opis / Description	Pak. Pack.	Bar kod EAN code
22552	H05VV-F 3G1,5 / 15m / ● 1 x / 1 x		8 605009 119863
22553	H05VV-F 3G1,5 / 20m / ● 1 x / 1 x		8 605009 119870
22554	H05VV-F 3G1,5 / 30m / ● 1 x / 1 x		8 605009 119887

NOSAČ KABLA / CABLE CARRIER

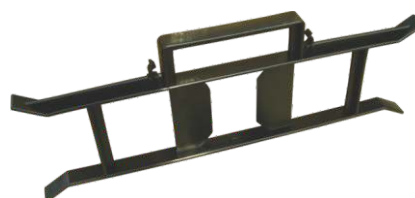

Šifra Code	Artikal / Article	Pak. Pack.	Bar kod EAN code
22106	NOSAČ KABLA CRNI / CABLE CARRIER BLACK		8 605009 1103732



JEDNOFAZNA PRIKLJUČNICA RAVNA
SINGLE PHASE STRAIGHT SOCKET



JEDNOFAZNI UTIKAČ POD UGLOM
SINGLE PHASE ANGLED PLUG







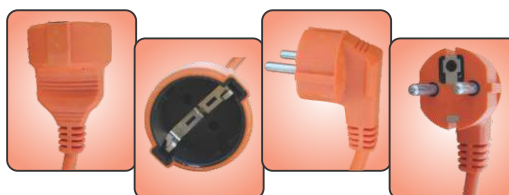







BOJA SAVITLJIVOG KABLA / CABLE COLOUR

JEDNOSTRUKA PRENOSNE PRIKLJUČNICE SINGLE PORTABLE SOCKETS-OUTLETS



PRENOSNA PRIKLJUČNICA NERASTAVNA / SINGLE PORTABLE SOCKET OUTLET
JEDNOSTRUKA SA SAVITLJIVIM KABLOM / UNWIREABLE WITH CABLE

Šifra Code	Opis / Description	Pak. Pack.	Bar kod EAN code
27377	H05VV-F 3G1,5 / 15m / ● 1 x  / 1 x 	 10	 8 605009 104111
27379	H05VV-F 3G1,5 / 20m / ● 1 x  / 1 x 	 8	 8 605009 104128
27381	H05VV-F 3G1,5 / 30m / ● 1 x  / 1 x 	 6	 8 605009 104135



JEDNOFAZNA PRIKLJUČNICA RAVNA
SINGLE PHASE STRAIGHT SOCKET







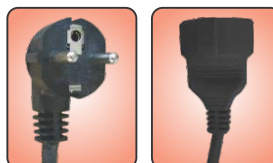







JEDNOFAZNI UTIKAČ POD UGLOM
SINGLE PHASE ANGLED PLUG





PRENOSNA PRIKLJUČNICA NERASTAVNA / *SINGLE PORTABLE SOCKET OUTLET*
 JEDNOSTRUKA SA SAVITLJIVIM KABLOM / *UNWIREABLE WITH CABLE*

Šifra <i>Code</i>	Opis / <i>Description</i>	Pak. <i>Pack.</i>	Bar kod <i>EAN code</i>
27378	H05VV-F 3G1,5 / 15m / ● 1 x  / 1 x 		 8 605009 104142
27380	H05VV-F 3G1,5 / 20m / ● 1 x  / 1 x 		 8 605009 104159
27382	H05VV-F 3G1,5 / 30m / ● 1 x  / 1 x 		 8 605009 104166



JEDNOFAZNA PRIKLJUČNICA RAVNA
SINGLE PHASE STRAIGHT SOCKET



JEDNOFAZNI UTIKAČ POD UGLOM
SINGLE PHASE ANGLED PLUG











BOJA SAVITLJIVOG KABLA / *CABLE COLOUR*

JEDNOSTRUKÉ PRENOSNE PRIKLJUČNICE

SINGLE PORTABLE SOCKETS-OUTLETS



PRENOSNA PRIKLJUČNICA NERASTAVNA / SINGLE PORTABLE SOCKET OUTLET JEDNOSTRUKA SA SAVITLJIVIM KABLOM / UNWIREABLE WITH CABLE

Šifra Code	Opis / Description	Pak. Pack.	Bar kod EAN code
5720	H05VV-F 3G1,5 / 3m /  1 x  / 1 x 		 8 605009 1103183
5721	H05VV-F 3G1,5 / 5m /  1 x  / 1 x 		 8 605009 1103190
29483	H05VV-F 3G1,5 / 10m /  1 x  / 1 x 		 8 605009 1128421
29484	H05VV-F 3G1,5 / 15m /  1 x  / 1 x 		 8 605009 1128438
29485	H05VV-F 3G2,5 / 3m /  1 x  / 1 x 		 8 605009 1128445
29486	H05VV-F 3G2,5 / 5m /  1 x  / 1 x 		 8 605009 1128452
18943	H05VV-F 3G2,5 / 10m /  1 x  / 1 x 		 8 605009 1128469
29487	H05VV-F 3G2,5 / 15m /  1 x  / 1 x 		 8 605009 1128476



JEDNOFAZNA PRIKLJUČNICA RAVNA
SINGLE PHASE STRAIGHT SOCKET



JEDNOFAZNI UTIKAČ POD UGLOM
SINGLE PHASE ANGLED PLUG



BOJA SAVITLJIVOG KABLA / CABLE COLOUR

VIŠESTRUKÉ PRENOSNE PRIKLJUČNICE *MULTIPLE PORTABLE SOCKET-OUTLETS*













VIŠESTRUKÉ PRENOSNE PRIKLJUČNICE

MULTIPLE PORTABLE SOCKET-OUTLETS



PRENOSNA PRIKLJUČNICA NERASTAVNA / 3-WAY PORTABLE SOCKET OUTLET TROSTRUKA KB-RB-03L SA SAVITLJIVIM KABLOM / KB-RB-03L UNWIREABLE

Šifra Code	Opis / Description	Pak. Pack.	Bar kod EAN code
21160	H05VV-F 3G1 / 2m 3 x  / 1 x  /  10A 250V ~ 2200W	 35	 8 605009 1122795 1
30880	H05VV-F 3G1,5 / 1,4m 3 x  / 1 x  /  16A 250V ~ 3500W	 40	 8 605009 1145411
15681	H05VV-F 3G1,5 / 2m 3 x  / 1 x  /  16A 250V ~ 3500W	 35	 8 605009 1122382 1
15682	H05VV-F 3G1,5 / 3m 3 x  / 1 x  /  16A 250V ~ 3500W	 30	 8 605009 1122405 1
15683	H05VV-F 3G1,5 / 5m 3 x  / 1 x  /  16A 250V ~ 3500W	 25	 8 605009 1122429 1

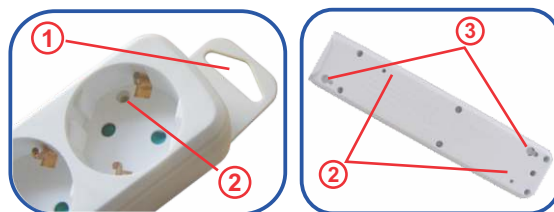

MOGUĆNOST MONTAŽE NA 3 NAČINA MOUNTING POSSIBILITY IN THREE WAYS



JEDNOFAZNA PRIKLJUČNICA
SINGLE PHASE SOCKET



JEDNOFAZNI UTIKAČ POD UGLOM
SINGLE PHASE ANGLED PLUG



PRIKLJUČNICE POSEDUJU ZAŠTITU ZA DECU!
WITH CHILDREN PROTECTION!



PRENOSNA PRIKLJUČNICA NERASTAVNA
ČETVOROSTRUKA KB-RB-04L SA SAVITLJIVIM KABLKOM

4-WAY PORTABLE SOCKET OUTLET
KB-RB-04L UNWIREABLE

Šifra Code	Opis / Description	Pak. Pack.	Bar kod EAN code
15689	H05VV-F 3G1,5 / 2m 4 x / 1 x / 16A 250V ~ 3500W	25	 8 605009 112249 8
15690	H05VV-F 3G1,5 / 3m 4 x / 1 x / 16A 250V ~ 3500W	25	 8 605009 112250 4
15691	H05VV-F 3G1,5 / 5m 4 x / 1 x / 16A 250V ~ 3500W	20	 8 605009 112251 1

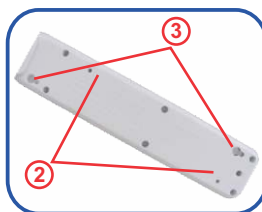
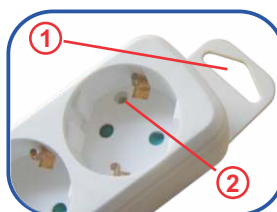

MOGUĆNOST MONTAŽE NA 3 NAČINA
MOUNTING POSSIBILITY IN THREE WAYS



JEDNOFAZNA PRIKLJUČNICA
SINGLE PHASE SOCKET



JEDNOFAZNI UTIKAČ POD UGLOM
SINGLE PHASE ANGLED PLUG



PRIKLJUČNICE POSEDUJU ZAŠTITU ZA DECU!
WITH CHILDREN PROTECTION!

VIŠESTRUKA PRENOSNE PRIKLJUČNICE MULTIPLE PORTABLE SOCKET-OUTLETS



**PRENOSNA PRIKLJUČNICA NERASTAVNA
PETOSTRUKA KB-RB-05L SA SAVITLJIVIM KABLOM**

**5-WAY PORTABLE SOCKET OUTLET
KB-RB-05L UNWIREABLE**

Šifra Code	Opis / Description	Pak. Pack.	Bar kod EAN code
21172	H05VV-F 3G1 / 2m 5 x  / 1 x  /  10A 250V ~ 2200W		 8 605009 112280 1
30882	H05VV-F 3G1,5 / 1,4m 5 x  / 1 x  /  16A 250V ~ 3500W		 8 605009 114543 5
15697	H05VV-F 3G1,5 / 2m 5 x  / 1 x  /  16A 250V ~ 3500W		 8 605009 112258 0
15698	H05VV-F 3G1,5 / 3m 5 x  / 1 x  /  16A 250V ~ 3500W		 8 605009 112260 3
15699	H05VV-F 3G1,5 / 5m 5 x  / 1 x  /  16A 250V ~ 3500W		 8 605009 112262 7

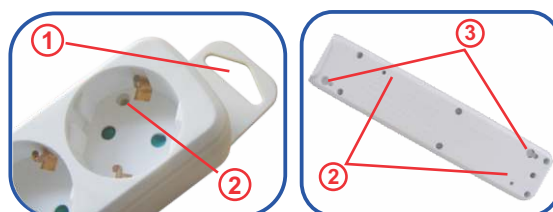

**MOGUĆNOST MONTAŽE NA 3 NAČINA
MOUNTING POSSIBILITY IN THREE WAYS**



JEDNOFAZNA PRIKLJUČNICA
SINGLE PHASE SOCKET



JEDNOFAZNI UTIKAČ POD UGLOM
SINGLE PHASE ANGLED PLUG

















PRIKLJUČNICE POSEDUJU ZAŠTITU ZA DECU!
WITH CHILDREN PROTECTION!



PRENOSNA PRIKLJUČNICA NERASTAVNA
ŠESTOSTRUKA KB-RB-06L SA SAVITLJIVIM KABLOM

6-WAY PORTABLE SOCKET OUTLET
KB-RB-06L UNWIREABLE

Šifra Code	Opis / Description	Pak. Pack.	Bar kod EAN code
15705	H05VV-F 3G1,5 / 2m 6 x  / 1 x  /  16A 250V ~ 3500W		 8 605009 122696
15706	H05VV-F 3G1,5 / 3m 6 x  / 1 x  /  16A 250V ~ 3500W		 8 605009 122702
15707	H05VV-F 3G1,5 / 5m 6 x  / 1 x  /  16A 250V ~ 3500W		 8 605009 122719

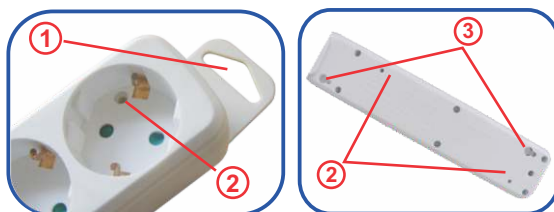

MOGUĆNOST MONTAŽE NA 3 NAČINA
MOUNTING POSSIBILITY IN THREE WAYS



JEDNOFAZNA PRIKLJUČNICA
SINGLE PHASE SOCKET



JEDNOFAZNI UTIKAČ POD UGLOM
SINGLE PHASE ANGLED PLUG

















PRIKLJUČNICE POSEDUJU ZAŠTITU ZA DECU!
WITH CHILDREN PROTECTION!

VIŠESTRUKÉ PRENOSNE PRIKLJUČNICE MULTIPLE PORTABLE SOCKET-OUTLETS



VIŠESTRUKÉ PRENOSNE PRIKLJUČNICE (PODSKLOP BEZ KABLA)

MULTIPLE PORTABLE SOCKET-OUTLETS (SUBASSEMBLY WITHOUT CORD)

Šifra Code	Opis / Description	Pak. Pack.	Bar kod EAN code
 15680	PRENOSNA PRIKLJUČNICA / 3-WAY PORTABLE SOCKET TROSTRUKA KB-RB-03L / OUTLET KB-RB-03L 3 x  / 	 75	 8 605009 112236 8
 15688	PRENOSNA PRIKLJUČNICA / 4-WAY PORTABLE SOCKET ČETVOROSTRUKA KB-RB-04L / OUTLET KB-RB-04L 4 x  / 	 60	 8 605009 112248 1
 15696	PRENOSNA PRIKLJUČNICA / 5-WAY PORTABLE SOCKET PETOSTRUKA KB-RB-05L / OUTLET KB-RB-05L 5 x  / 	 60	 8 605009 112256 1
 15704	PRENOSNA PRIKLJUČNICA / 6-WAY PORTABLE SOCKET ŠESTOSTRUKA KB-RB-06L / OUTLET KB-RB-06L 6 x  / 	 50	 8 605009 112268 9

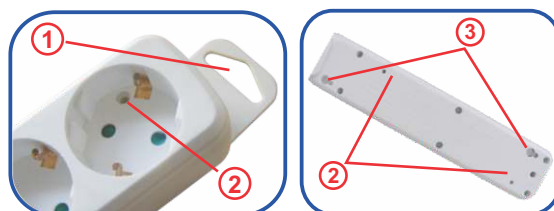













MOGUĆNOST MONTAŽE NA 3 NAČINA
MOUNTING POSSIBILITY IN THREE WAYS



PRENOSNA PRIKLJUČNICA NERASTAVNA
 TROSTRUKA KB-RB-03KL SA SAVITLJIVIM KABLOM
 I DVOPOLNOM INDIKATORSKOM SKLOPKOM

3-WAY PORTABLE SOCKET OUTLET
 KB-RB-03KL UNWIREABLE WITH
 TWO-POLE INDICATION SWITCH

Šifra Code	Opis / Description	Pak. Pack.	Bar kod EAN code
21184	H05VV-F 3G1 / 2m 3 x  / 1 x  /  /  10A 250V ~ 2200W	 30	 8 605009 112839 1
30881	H05VV-F 3G1,5 / 1,4m 3 x  / 1 x  /  /  16A 250V ~ 3500W	 35	 8 605009 114542 8
15685	H05VV-F 3G1,5 / 2m 3 x  / 1 x  /  /  16A 250V ~ 3500W	 35	 8 605009 112245 0
15686	H05VV-F 3G1,5 / 3m 3 x  / 1 x  /  /  16A 250V ~ 3500W	 30	 8 605009 112246 7
15687	H05VV-F 3G1,5 / 5m 3 x  / 1 x  /  /  16A 250V ~ 3500W	 25	 8 605009 112247 4

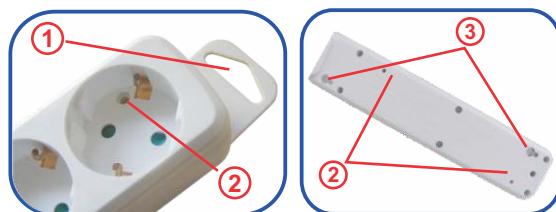

MOGUĆNOST MONTAŽE NA 3 NAČINA
 MOUNTING POSSIBILITY IN THREE WAYS



JEDNOFAZNA PRIKLJUČNICA
 SINGLE PHASE SOCKET



JEDNOFAZNI UTIKAČ POD UGLOM
 SINGLE PHASE ANGLED PLUG



ON/OFF INDIKATORSKA SKLOPKA
 ON/OFF INDICATION SWITCH





















PRIKLJUČNICE POSEDUJU ZAŠTITU ZA DECU!
 WITH CHILDREN PROTECTION!



PRENOSNA PRIKLJUČNICA NERASTAVNA
 ČETVOROSTRUKA KB-RB-04KL SA SAVITLJIVIM
 KABLOM I DVOPOLNOM INDIKATORSKOM SKLOPKOM

4-WAY PORTABLE SOCKET OUTLET
 KB-RB-04KL UNWIREABLE WITH
 TWO-POLE INDICATION SWITCH

Šifra Code	Opis / Description	Pak. Pack.	Bar kod EAN code
15693	H05VV-F 3G1,5 / 2m 4 x  / 1 x  /  /  16A 250V ~ 3500W		 8 605009 1122535
15694	H05VV-F 3G1,5 / 3m 4 x  / 1 x  /  /  16A 250V ~ 3500W		 8 605009 1122542
15695	H05VV-F 3G1,5 / 5m 4 x  / 1 x  /  /  16A 250V ~ 3500W		 8 605009 1122559

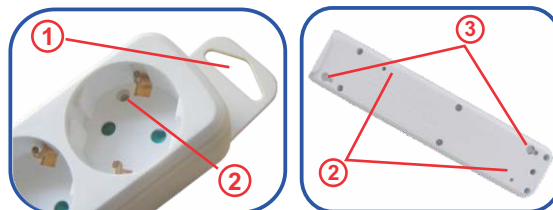

MOGUĆNOST MONTAŽE NA 3 NAČINA
 MOUNTING POSSIBILITY IN THREE WAYS



JEDNOFAZNA PRIKLJUČNICA
 SINGLE PHASE SOCKET



JEDNOFAZNI UTIKAČ POD UGLOM
 SINGLE PHASE ANGLED PLUG



ON/OFF INDIKATORSKA SKLOPKA
 ON/OFF INDICATION SWITCH



PRIKLJUČNICE POSEDUJU ZAŠTITU ZA DECU!
 WITH CHILDREN PROTECTION!



PRENOSNA PRIKLJUČNICA NERASTAVNA
 PETOSTRUKA KB-RB-05KL SA SAVITLJIVIM KABLOM
 I DVOPOLNOM INDIKATORSKOM SKLOPKOM

5-WAY PORTABLE SOCKET OUTLET
 KB-RB-05KL UNWIREABLE WITH
 TWO-POLE INDICATION SWITCH

Šifra Code	Opis / Description	Pak. Pack.	Bar kod EAN code
21196	H05VV-F 3G1 / 2m 5 x  / 1 x  /  /  10A 250V ~ 2200W		 8 605009 1128407
30883	H05VV-F 3G1,5 / 1,4m 5 x  / 1 x  /  /  16A 250V ~ 3500W		 8 605009 1145442
15701	H05VV-F 3G1,5 / 2m 5 x  / 1 x  /  /  16A 250V ~ 3500W		 8 605009 1122658
15702	H05VV-F 3G1,5 / 3m 5 x  / 1 x  /  /  16A 250V ~ 3500W		 8 605009 1122665
15703	H05VV-F 3G1,5 / 5m 5 x  / 1 x  /  /  16A 250V ~ 3500W		 8 605009 1122672

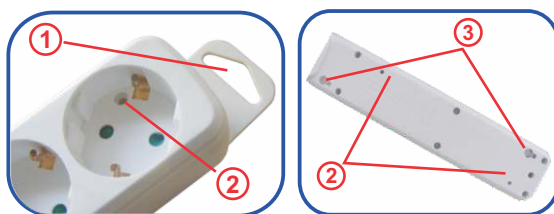

MOGUĆNOST MONTAŽE NA 3
 MOUNTING POSSIBILITY IN THREE WAYS



JEDNOFAZNA PRIKLJUČNICA
 SINGLE PHASE SOCKET



JEDNOFAZNI UTIKAČ POD UGLOM
 SINGLE PHASE ANGLED PLUG



ON/OFF INDIKATORSKA SKLOPKA
 ON/OFF INDICATION SWITCH





















PRIKLJUČNICE POSEDUJU ZAŠTITU ZA DECU!
 WITH CHILDREN PROTECTION!



**PRENOSNA PRIKLJUČNICA NERASTAVNA
 ŠESTOSTRUKA KB-RB-06KL SA SAVITLJIVIM KABLOM
 I DVOPOLNOM INDIKATORSKOM SKLOPKOM**

**6-WAY PORTABLE SOCKET OUTLET
 KB-RB-06KL UNWIREABLE WITH
 TWO-POLE INDICATION SWITCH**

Šifra Code	Opis / Description	Pak. Pack.	Bar kod EAN code
15709	H05VV-F 3G1,5 / 2m 6 x  / 1 x  /  /  16A 250V ~ 3500W	 20	 8 605009 122733
15710	H05VV-F 3G1,5 / 3m 6 x  / 1 x  /  /  16A 250V ~ 3500W	 15	 8 605009 122740
15711	H05VV-F 3G1,5 / 5m 6 x  / 1 x  /  /  16A 250V ~ 3500W	 15	 8 605009 122757

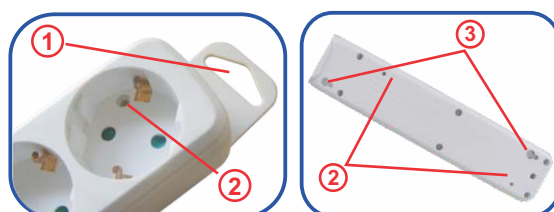

**MOGUĆNOST MONTAŽE NA 3 NAČINA
 MOUNTING POSSIBILITY IN THREE WAYS**



JEDNOFAZNA PRIKLJUČNICA
 SINGLE PHASE SOCKET



JEDNOFAZNI UTIKAČ POD UGLOM
 SINGLE PHASE ANGLED PLUG



ON/OFF INDIKATORSKA SKLOPKA
 ON/OFF INDICATION SWITCH



PRIKLJUČNICE POSEDUJU ZAŠTITU ZA DECU!
 WITH CHILDREN PROTECTION!

VIŠESTRUKI PRENOSNE PRIKLJUČNICE SA DVOPOLNOM INDIKATORSKOM SKLOPKOM (PODSKLOP BEZ KABLA) / MULTIPLE PORTABLE SOCKET-OUTLETS WITH TWO-POLE INDICATION SWITCH (SUBASSEMBLY WITHOUT CORD)

Šifra Code	Opis / Description	Pak. Pack.	Bar kod EAN code
 15684	PRENOSNA PRIKLJUČNICA / 3-WAY PORTABLE SOCKET TROSTRUKA KB-RB-03KL / OUTLET KB-RB-03KL 3 x  /  / 	 60	 8 605009 112244 3
 15692	PRENOSNA PRIKLJUČNICA / 4-WAY PORTABLE SOCKET ČETVOROSTRUKA KB-RB-04KL / OUTLET KB-RB-04KL 4 x  /  / 	 60	 8 605009 112252 8
 15700	PRENOSNA PRIKLJUČNICA / 5-WAY PORTABLE SOCKET PETOSTRUKA KB-RB-05KL / OUTLET KB-RB-05KL 5 x  /  / 	 50	 8 605009 112264 1
 15708	PRENOSNA PRIKLJUČNICA / 6-WAY PORTABLE SOCKET ŠESTOSTRUKA KB-RB-06KL / OUTLET KB-RB-06KL 6 x  /  / 	 35	 8 605009 112272 6

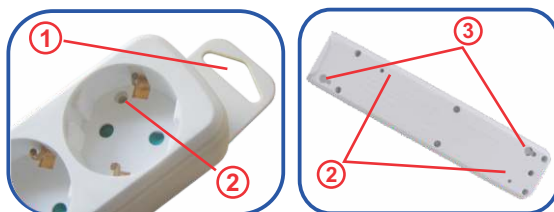

MOGUĆNOST MONTAŽE NA 3 NAČINA
 MOUNTING POSSIBILITY IN THREE WAYS



JEDNOFAZNA PRIKLJUČNICA
 SINGLE PHASE SOCKET



ON/OFF INDIKATORSKA SKLOPKA
 ON/OFF INDICATION SWITCH



PRIKLJUČNICE POSEDUJU ZAŠTITU ZA DECU!
 WITH CHILDREN PROTECTION!

KABLOVSKE MOTALICE

CABLE REELS

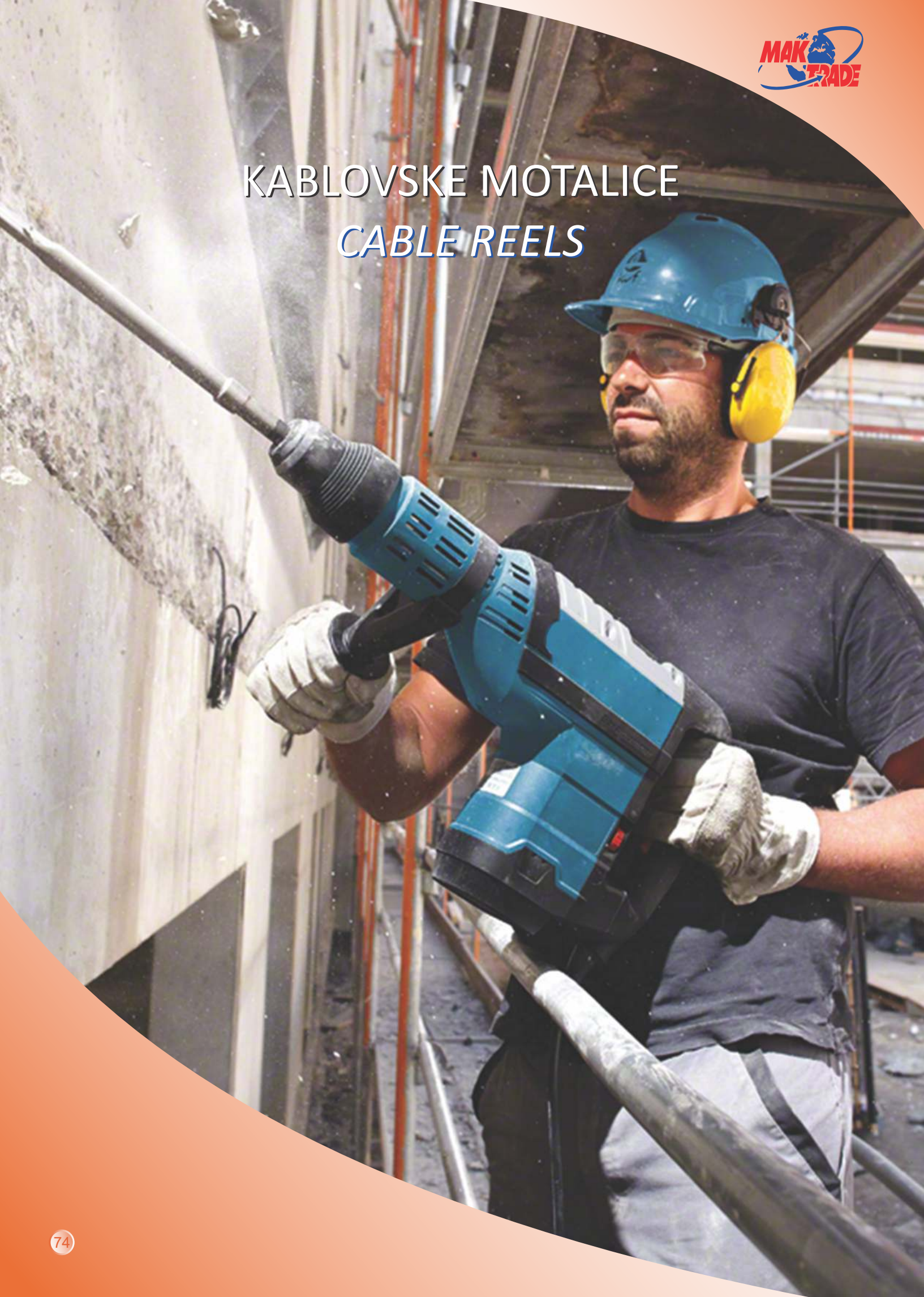



Šifra Code	Opis / Description	Pak. Pack.	Bar kod EAN code
7333	Model: MT250A H05VV-F 3G1,5 / 25m / Ø 240mm 4 x / 1 x / OVERLOAD 16A 250V ~ 3000W IP20		 816050091104616
8315	Model: MT250B H05VV-F 3G2,5 / 25m / Ø240mm 4 x / 1 x / OVERLOAD 16A 250V ~ 3500W IP20		 816050091104654
7334	Model: MT252A H05VV-F 3G1,5 / 50m / Ø 290mm 4 x / 1 x / OVERLOAD 16A 250V ~ 3000W IP20		 816050091104623
9957	Model: MT252B H05VV-F 3G2,5 / 50m / Ø 290mm 4 x / 1 x / OVERLOAD 16A 250V ~ 3500W IP20		 816050091104661



Šifra Code	Opis / Description	Pak. Pack.	Bar kod EAN code
7335	Model: MT248A H05VV-F 3G1,5 / 25m / Ø 260mm 4 x / 1 x / OVERLOAD 16A 250V ~ 3000W IP20		 816050091104609
7627	Model: MT248B H05VV-F 3G2,5 / 25m / Ø 260mm 4 x / 1 x / OVERLOAD 16A 250V ~ 3500W IP20		 816050091104630
7336	Model: MT255A H05VV-F 3G1,5 / 50m / Ø 290mm 4 x / 1 x / OVERLOAD 16A 250V ~ 3000W IP20		 816050091104593



JEDNOFAZNA PRIKLJUČNICA
SINGLE PHASE SOCKET



UGRAĐENA ZAŠTITA OD
PREOPTEREĆENJA-TERMOPREKIDAČ
BUILT-IN OVERLOAD PROTECTION-THERMO SWITCH



JEDNOFAZNI UTIKAČ POD UGLOM
SINGLE PHASE ANGLED PLUG



PVC BUBANJ
PLASTIC REEL



METALNI BUBANJ
METAL REEL



Šifra Code	Opis / Description	Pak. Pack.	Bar kod EAN code
31100	Model: MT249 H05VV-F 3G1,5 / 15m (p) / Ø 180mm 4 x (1) / 1 x (1)		 8 1605009 1145763



Šifra Code	Opis / Description	Pak. Pack.	Bar kod EAN code
7365	Model: MT259A H05VV-F 3G2,5 / 50m (m) / Ø 320mm 3 x (1) / 1 x (1)		 8 1605009 1104586

Šifra Code	Opis / Description	Pak. Pack.	Bar kod EAN code
7364	Model: MT259 H05RR-F 3G2,5 / 50m (m) / Ø 320mm 3 x (1) / 1 x (1)		 8 1605009 1104579



JEDNOFAZNA PRIKLJUČNICA
SINGLE PHASE SOCKET



PVC BUBANJ
PLASTIC REEL



JEDNOFAZNI UTIKAČ POD UGLOM
SINGLE PHASE ANGLED PLUG



METALNI BUBANJ
METAL REEL



Šifra Code	Opis / Description	Pak. Pack.	Bar kod EAN code
7322	Model: MT250 H05RR-F 3G1,5 / 25m / Ø 240mm 4 x / 1 x / OVERLOAD 16A 250V ~ 3000W IP20		
13247	Model: MT250C H05RR-F 3G2,5 / 25m / Ø 240mm 4 x / 1 x / OVERLOAD 16A 250V ~ 3500W IP20		
7325	Model: MT252 H05RR-F 3G1,5 / 50m / Ø 290mm 4 x / 1 x / OVERLOAD 16A 250V ~ 3000W IP20		
7328	Model: MT252C H05RR-F 3G2,5 / 50m / Ø 290mm 4 x / 1 x / OVERLOAD 16A 250V ~ 3500W IP20		



Šifra Code	Opis / Description	Pak. Pack.	Bar kod EAN code
7321	Model: MT248 H0RR-F 3G1,5 / 25m / Ø 260mm 4 x / 1 x / OVERLOAD 16A 250V ~ 3000W IP20		
19784	Model: MT248C H05RR-F 3G2,5 / 25m / Ø 260mm 4 x / 1 x / OVERLOAD 16A 250V ~ 3500W IP20		
7324	Model: MT255 H05RR-F 3G1,5 / 50m / Ø 290mm 4 x / 1 x / OVERLOAD 16A 250V ~ 3000W IP20		



JEDNOFAZNA PRIKLJUČNICA
SINGLE PHASE SOCKET



UGRAĐENA ZAŠTITA OD
PREOPTEREĆENJA-TERMOPREKIDAČ
BUILT-IN OVERLOAD PROTECTION-THERMO SWITCH



JEDNOFAZNI UTIKAČ POD UGLOM
SINGLE PHASE ANGLED PLUG



PVC BUBANJ
PLASTIC REEL



METALNI BUBANJ
METAL REEL

KABLOVSKA MOTALICA NA KOLICIMA / CABLE REEL ON WHEELCHAIR



Šifra Code	Opis / Description	Pak. Pack.	Bar kod EAN code
21899	Model: MT208B H05VV-F 5G1,5 / 50m (m) / Ø 430mm 2 x (1) / 2 x (3) / 1 x (3) = 3x16A 440V ~ 10000W IP44		
21898	Model: MT208A H05VV-F 5G2,5 / 50m (m) / Ø 430mm 2 x (1) / 2 x (3) / 1 x (3) = 3x16A 440V ~ 12000W IP44		
7323	Model: MT208 H05RR-F 5G2,5 / 50m (m) / Ø 430mm 2 x (1) / 2 x (3) / 1 x (3) = 3x16A 440V ~ 12000W IP44		



Šifra Code	Opis / Description	Pak. Pack.	Bar kod EAN code
7320	Model: MT213 H05VV-F 5G2,5 / 100m (m) / Ø 500mm 2 x (1) / 2 x (CEE) / 1 x (3) = 3x16A 440V ~ 12000W IP44		

KABLOVSKA MOTALICA SA RAZVODNOM KUTIJOM / CABLE REEL WITH DISTRIBUTION BOX



Šifra Code	Opis / Description	Pak. Pack.	Bar kod EAN code
7326	Model: MT219 H05RR-F 5G2,5 / 50m (m) / Ø 430mm 1 x (1) / 1 x (3) / 1 x (CEE) 1x16A 1 x (CEE) 3x16A / 1 x (3) = 8 x (MCB) C16A 3x16A 440V ~ 12000W IP44		



JEDNOFAZNA PRIKLJUČNICA
SINGLE PHASE SOCKET



TROFAZNA PRIKLJUČNICA
THREE PHASE SOCKET



TROFAZNI UTIKAČ POD UGLOM
THREE PHASE ANGLED PLUG



CEE RAVNA PRIKLJUČNICA
CEE STRAIGHT SOCKET



AUTOMATSKI OSIGURAČ
MINIATURE CIRCUIT BREAKER



METALNI BUBANJ
METAL REEL



Šifra Code	Opis / Description	Pak. Pack.	Bar kod EAN code
29588	Model: MT201A H05VV-F 5G2,5 / 50m / Ø 430mm 2 x / 2 x / 1 x 3x16A 440V ~ 12000W IP44		816050091145855
30823	Model: MT201B H05RR-F 5G2,5 / 50m / Ø 430mm 2 x / 2 x / 1 x 3x16A 440V ~ 12000W IP44		816050091145848
31462	Model: MT201C H05VV-F 5G2,5 / 25m / Ø 430mm 2 x / 2 x / 1 x 3x16A 440V ~ 12000W IP44		816050091128865

KABLOVSKA MOTALICA TROFAZNA (KOMBINOVANA) / CABLE REEL THREE-PHASE (COMBINED)



Šifra Code	Opis / Description	Pak. Pack.	Bar kod EAN code
29590	Model: MT260A H05VV-F 5G2,5 / 30m / Ø 370mm 2 x / 1 x / 1 x 3x16A 440V ~ 12000W IP20		816050091145930
29589	Model: MT260B H05VV-F 5G2,5 / 40m / Ø 370mm 2 x / 1 x / 1 x 3x16A 440V ~ 12000W IP20		816050091145947
7349	Model: MT260C H05RR-F 5G2,5 / 30m / Ø 370mm 2 x / 1 x / 1 x 3x16A 440V ~ 12000W IP20		816050091145954
7350	Model: MT260D H05RR-F 5G2,5 / 40m / Ø 370mm 2 x / 1 x / 1 x 3x16A 440V ~ 12000W IP20		816050091145961



JEDNOFAZNA PRIKLJUČNICA
SINGLE PHASE SOCKET



TROFAZNA PRIKLJUČNICA
THREE PHASE SOCKET



TROFAZNI UTIKAČ POD UGLOM
THREE PHASE ANGLED PLUG



METALNI BUBANJ
METAL REEL



Šifra Code	Opis / Description	Pak. Pack.	Bar kod EAN code
30904	Model: MT258 H05RR-F 3G2,5 / 50m (m) / Ø 370mm 4 x (i) / 1 x CEE		 8 605 009 112727 1



Šifra Code	Opis / Description	Pak. Pack.	Bar kod EAN code
30905	Model: MT207 H05RR-F 5G2,5 / 40m (m) / Ø 270mm 2 x CEE / 2 x (i) / 1 x CEE		 8 605 009 112726 4



JEDNOFAZNA PRIKLJUČNICA
SINGLE PHASE SOCKET



CEE RAVNA PRIKLJUČNICA
CEE STRAIGHT SOCKET



CEE RAVAN UTIKAČ
CEE STRAIGHT PLUG



METALNI BUBANJ
METAL REEL

PRENOSIVI GRAĐEVINSKI ORMANI
KABLOVSKA SPOJNICA
SABIRNICE
RAZVODNE KUTIJE OG
MOTORNA ZAŠTITNA SKLOPKA

*PORTABLE POWER DISTRIBUTION BOARDS
CABLE CONNECTOR
TERMINAL CONNECTORS
JUNCTION BOX
MANUAL MOTOR PROTECTOR/STARTER*

PRENOSIVI GRAĐEVINSKI ORMANI IP44

PORTABLE POWER DISTRIBUTION BOARDS IP44



Šifra Code	Opis / Description	Pak. Pack.	Bar kod EAN code
30898	Model: TIP-1 H05RR-F 5G4 / 20m 1 x 32A 6 x 16A / 3 x 16A / 2 x 32A 14 x C16A / 6 x 32A 1 x 63/0,5A 4P 32A, 440V/50Hz, IP44		 8 605009 128094



Šifra Code	Opis / Description	Pak. Pack.	Bar kod EAN code
30916	Model: TIP-2 H05RR-F 5G2,5 / 20m 1 x 16A 6 x 16A / 3 x 16A 15 x C16A 1 x 40/0,5A 4P 16A, 440V/50Hz, IP44		 8 605009 128100



Šifra Code	Opis / Description	Pak. Pack.	Bar kod EAN code
30917	Model: TIP-3 H05RR-F 5G4 / 5m 1 x 32A 4 x 16A / 1 x 16A / 1 x 32A 5 x C16A / 3 x 32A 1 x 40/0,5A 4P 32A, 440V/50Hz, IP44		 8 605009 128117



JEDNOFAZNA PRIKLJUČNICA
SINGLE PHASE SOCKET



CEE RAVNA PRIKLJUČNICA
CEE STRAIGHT SOCKET



CEE RAVAN UTIKAČ
CEE STRAIGHT PLUG



AUTOMATSKI OSIGURAČ
MINIATURE CIRCUIT BREAKER



AUTOMATSKA SKLOPKA - FID SKLOPKA
RESIDUAL CURRENT CIRCUIT BREAKER



Šifra Code	Opis / Description	Pak. Pack.	Bar kod EAN code
30898A	<p>Model: TIP-1A H05RR-F 5G4 / 20m 1 x 32A</p> <p>3 x 16A / 2 x 16A / 1 x 32A</p> <p>9 x C16A / 3 x 32A</p> <p>1 x 63/0,5A 4P 32A, 440V/50Hz, IP66</p>		 8 605009 128285



Šifra Code	Opis / Description	Pak. Pack.	Bar kod EAN code
30916A	<p>Model: TIP-2A H05RR-F 5G2,5 / 20m 1 x 16A</p> <p>3 x 16A / 3 x 16A</p> <p>12 x C16A</p> <p>1 x 40/0,5A 4P 16A, 440V/50Hz, IP66</p>		 8 605009 128292



Šifra Code	Opis / Description	Pak. Pack.	Bar kod EAN code
30917A	<p>Model: TIP-3A H05RR-F 5G4 / 5m 1 x 32A</p> <p>4 x 16A / 1 x 16A / 1 x 32A</p> <p>5 x C16A / 3 x 32A</p> <p>1 x 40/0,5A 4P 32A, 440V/50Hz, IP66</p>		 8 605009 128308



JEDNOFAZNA PRIKLJUČNICA
SINGLE PHASE SOCKET



CEE RAVNA PRIKLJUČNICA
CEE STRAIGHT SOCKET



CEE RAVAN UTIKAČ
CEE STRAIGHT PLUG



AUTOMATSKI OSIGURAČ
MINIATURE CIRCUIT BREAKER



AUTOMATSKA SKLOPKA - FID SKLOPKA
RESIDUAL CURRENT CIRCUIT BREAKER





NAMENA

Najbolji mogući način da se povežu dva kabla je uz pomoć kablovske spojnice, naročito u slučaju kada se zahteva visoka sigurnost kontakta. Mesingani kontakti koji se nalaze unutar kablovske spojnice omogućuju optimalnu provodljivost kablova. Kontakti su ugrađeni u specijalnu klemu otpornu na visoke temperature. Ova klema se može lako montirati i demontirati. Spojnica je postavljena tako da štiti kablovske spojeve od mehaničkih oštećenja i sa obe strane ima uvednike koji pružaju IP67 zaštitu, čak i u ekstremnim uslovima.

PURPOSE

The best possible way to connect two cables is with cable connector, especially in cases when high security of contact is needed. Brass contacts which are inside of cable connector provides optimal conductivity of cables. Contacts are build in special terminal, resistant to high temperatures. This terminal is easy to assemble or disassemble. Connector protects cable contacts from mechanical damage and on both sides has cable entry which provides IP67 protection even in extreme conditions.

Šifra Code	Uvodnik Cable gland	Prečnik kablova Cable diameters	Pak. Pack.	Bar kod EAN code
26340	PG16	5x1,5mm ² , 3x2,5mm ² , 5x2,5mm ²	100	 8 1605009 118231
26341	PG21	5x4mm ² , 5x6mm ²	50	 8 1605009 118248

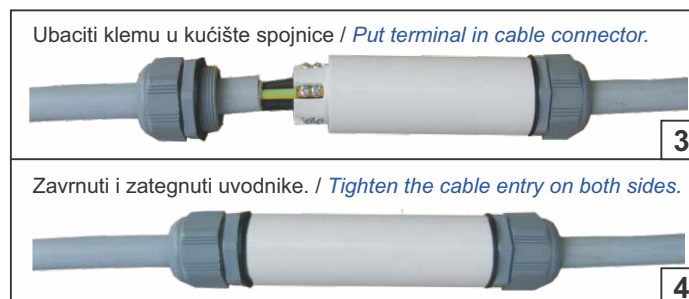
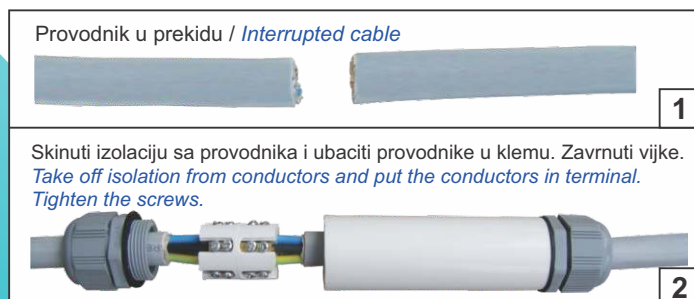

IP67

Lenght
Dužina

115mm
124mm

Ø





26,5mm
33,5mm

mm²

1,5 / 2,5
4 / 6

PG16
PG21



Šifra Code	Opis / Description	Pak. Pack.	Bar kod EAN code
20134	6x9 1 metar		 8 605009 130158
20089	6x9 4P		 8 605009 130165
20090	6x9 6P		 8 605009 130172
20091	6x9 8P		 8 605009 130189
20092	6x9 10P		 8 605009 130196
20093	6x9 12P		 8 605009 130202

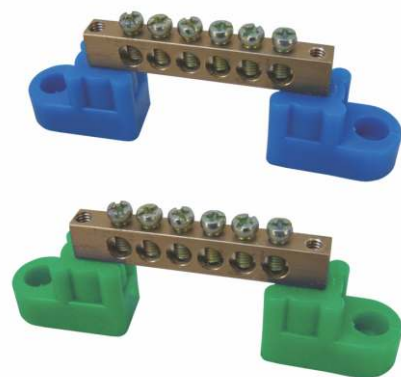

Šifra Code	Opis / Description	Pak. Pack.	Bar kod EAN code
20099	6x9 4P - Model 1 / ●		 8 605009 130219
20094	6x9 4P - Model 1 / ●		 8 605009 130226
20100	6x9 6P - Model 1 / ●		 8 605009 130233
20095	6x9 6P - Model 1 / ●		 8 605009 130240
20101	6x9 8P - Model 1 / ●		 8 605009 130257
20096	6x9 8P - Model 1 / ●		 8 605009 130264
20102	6x9 10P - Model 1 / ●		 8 605009 130271
20097	6x9 10P - Model 1 / ●		 8 605009 130288
20103	6x9 12P - Model 1 / ●		 8 605009 130295
20098	6x9 12P - Model 1 / ●		 8 605009 130301
23906	6x9 16P - Model 1 / ●		 8 605009 130516
31658	6x9 16P - Model 1 / ●		 8 605009 130523
31659	6x9 20P - Model 1 / ●		 8 605009 130530
31660	6x9 20P - Model 1 / ●		 8 605009 130547





Šifra Code	Opis / Description	Pak. Pack.	Bar kod EAN code
20104	6x9 4P - Model 2 / ●		
20109	6x9 4P - Model 2 / ●		
20105	6x9 6P - Model 2 / ●		
20110	6x9 6P - Model 2 / ●		
20106	6x9 8P - Model 2 / ●		
20111	6x9 8P - Model 2 / ●		
20107	6x9 10P - Model 2 / ●		
20112	6x9 10P - Model 2 / ●		
20108	6x9 12P - Model 2 / ●		
20113	6x9 12P - Model 2 / ●		



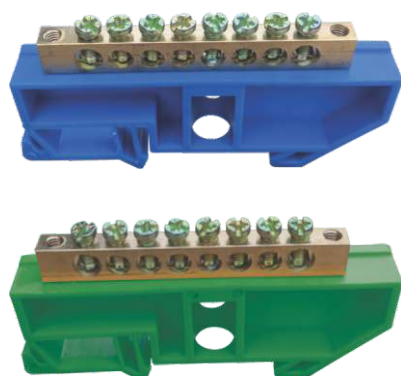

Šifra Code	Opis / Description	Pak. Pack.	Bar kod EAN code
20115	6x9 4P - Model 3 / ●		8 605009 130417
20119	6x9 4P - Model 3 / ●		8 605009 130424
20116	6x9 6P - Model 3 / ●		8 605009 130431
20120	6x9 6P - Model 3 / ●		8 605009 130448
20117	6x9 8P - Model 3 / ●		8 605009 130455
20121	6x9 8P - Model 3 / ●		8 605009 130462
20118	6x9 10P - Model 3 / ●		8 605009 130479
20122	6x9 10P - Model 3 / ●		8 605009 130486
20114	6x9 12P - Model 3 / ●		8 605009 130493
20123	6x9 12P - Model 3 / ●		8 605009 130509



Razvodna kutija OG sa 6 uvodnica nazidna 85x85x50 / *Wall mounted junction box 85x85x50*

- Ugradnja na zid pomoću vijaka 4mm
- Uvodnice za kablove do Ø20mm

- *Wall mounting by screws diam. to 4mm*
- *Cable bushings to Ø20mm*



napon

500V

voltage

zaštita

IP-54

protection

Šifra <i>Code</i>	Broj uvodnica <i>No. of cable glands</i>	Dimenzije / <i>Dimensions</i>	Pak. <i>Pack.</i>	Bar kod <i>EAN code</i>
8432	6	85x85x50		



napon

500V

voltage

zaštita

IP-54

protection

Šifra <i>Code</i>	Broj uvodnica <i>No. of cable glands</i>	Dimenzije / <i>Dimensions</i>	Pak. <i>Pack.</i>	Bar kod <i>EAN code</i>
31392	6	100x100x50		

Dimenzije / *Dimensions:*

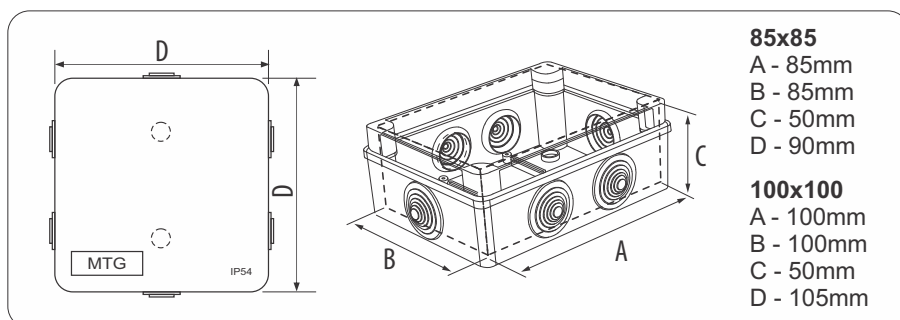

Razvodna kutija OG nazidna 100x100x60 sa vijcima / Wall mounted junction box 100x100x60 with screws



napon

500V

voltage

zaštita

IP-65

protection



Dimenzije / Dimensions:

A - 100mm
B - 100mm
C - 60mm

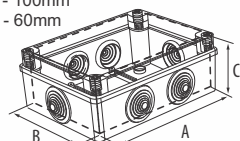

Šifra Code	Broj uvodnica No. of cable glands	Dimenzije / Dimensions	Pak. Pack.	Bar kod EAN code
31394	—	100x100x60		8 605009 128759



napon

500V

voltage

zaštita

IP-55

protection



Dimenzije / Dimensions:

A - 100mm
B - 100mm
C - 60mm

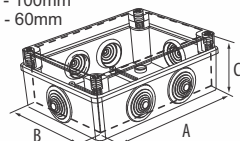

Šifra Code	Broj uvodnica No. of cable glands	Dimenzije / Dimensions	Pak. Pack.	Bar kod EAN code
31393	6	100x100x60		8 605009 128742

Kabloske uvodnice PVC / Cable glands PVC



Šifra Code	Artikal / Article	Opis / Description	Pak. Pack.	Bar kod EAN code
31722	za kablove do Ø20 mm beli for cables up to Ø20 mm white	Ugradnja u otvor Ø25 mm Mounting into the hole Ø25 mm		8 605009 127134



Šifra Code	Artikal / Article	Opis / Description	Pak. Pack.	Bar kod EAN code
31722A	za kablove do Ø20 mm sivi for cables up to Ø20 mm grey	Ugradnja u otvor Ø25 mm Mounting into the hole Ø25 mm		8 605009 127141



NAMENA

Motorna zaštitna sklopka služi za uklop i isklup trofaznih opterećenja, prvenstveno pojedinih elektromotora, odnosno za zaštitu od preopterećenja.

Koristi se kao zaštitni uređaj koji obezbeđuje priključenje motora naizmjenične struje uz istovremenu višestruku zaštitu:

- zaštita od preopterećenja,
- termička zaštita (zaštita od pregrevanja),
- zaštita pri kratkim spojevima,
- zaštita prilikom ispada jedne faze, i
- zaštita pri nedozvoljenim padovima napona.

PURPOSE

Manual motor starters are protection devices. They combine motor control (mainly to switch motors manually ON/OFF) and protection.

As protection device they are suitable for three-and single-phase applications providing multiple protection:

- protection from overload,
- thermal protection against overheating,
- phase failures protection,
- under-voltage and over-voltage protections,
- in combination with insulation fuse they provide protection against short-circuit overload.

TEHNIČKI PODACI

- Montaža na DIN šinu
- Način montaže: vertikalni pad pod max. uglom $\pm 5^\circ$
- Radna temperatura okoline: -10°C - $+65^\circ\text{C}$
- Nominalni radni napon $U_e(\text{V})$: 230/240, 400/415, 440, 500 i 660
- Frekvencija: 50/60 Hz
- Napon izolacije: 660V
- Električni životni vek (broj uključenja/isključenja) $\geq 10^6$
- Mehanički životni vek (broj uključenja/isključenja) ≥ 100.000
- Prekidač poseduje integrisane No/Nc pomoćne kontakte
- Nazivni podnosivi impulsni napon: 6kV
- Stepen zaštite : IP 41
- Stepen zaštite: IP 55 postiže se smeštanjem 3VE1 sklopke u kućište sa upotrebom odgovarajućeg Au-ZnAl uvodnika sa gumenom zaptivkom

TECHNICAL DATA

- DIN rail montage
- Mounting: vertical with max. angle $\pm 5^\circ$
- Nominal working voltage: $U_e(\text{V})$ 230/240, 400/415, 440, 500 and 660
- Rated operational voltage: 660V
- Rated insulation voltage: 660V
- Electrical life (close-open operations for AC-3 duty) 10^5
- Mechanical life (close-open operations) ≥ 100.000
- This type of motor starter have integrated No/Nc auxiliary contacts
- Rated impulse withstand voltage: 6kV
- Degree of protection : IP 41
- Degree of protection: IP 55 is achieved by placing the 3VE1 switch at the housing with a use of the respective Au-ZnAl cable gland with rubber sealing

Tabela 1. Opsezi termičkih struja za monofazne i trofazne potrošače
Table 1. Current range settings for single and three - phase applications

Snaga i struja motora / Power and current of the motor		Podešavanje opsega za zaštitu od preopterećenja / Current setting range		Snaga i struja motora / Power and current of the motor		Podešavanje opsega za zaštitu od preopterećenja / Current setting range			
1 - fazni / 1-phase 230 - 240V				3 - fazni / 3-phase 400 - 414V				aM(A)	gL(A)
(kW)	(A)	(A)		(kW)	(A)	(A)			
0,06	0,7	0,63 - 1		0,06	0,2	0,16 - 0,25		-	1
0,09	0,7	0,63 - 1		0,09	0,3	0,25 - 0,4		1	2
0,12	1,3	1 - 1,6		0,12	0,4	0,4 - 0,63		1	2
0,18	1,9	1,6 - 2,5		0,18	0,6	0,4 - 0,63		1	2
0,25	2,4	1,6 - 2,5		0,25	0,8	0,63 - 1		1	2
0,37	2,9	2,5 - 4		0,37	1,1	1 - 1,6		2	4
0,55	4,2	4 - 6,3		0,55	1,5	1 - 1,6		2	4
0,75	5,6	4 - 6,3		0,75	1,9	1,6 - 2,5		4	6
1,1	7,4	6,3 - 10		1,1	2,6	2,5 - 4		6	10
1,5	8,9	6,3 - 10		1,5	3,6	2,5 - 4		6	10
2,2	14,5	10 - 16		2,2	5,0	4 - 6,3		10	16
3	17,8	14 - 20		2,5 - 3,0	6,6	6,3 - 10		10	20
				4,0	8,5	6,3 - 10		10	20
				5,5	11,3	10 - 16		16	25
				7,5	13,2	10 - 16		16	25
				11,0	21,7	16 - 25		25	50
				15,0	29,3	25 - 40		40	63
				18,5	36,0	25 - 40		40	63

ŠEMA POVEZIVANJA / CONNECTION DIAGRAM

Sve sklopke su realizovane kao tropolne ali sa odgovarajućim povezivanjem može se postići da se one koriste i kao jedнопolne (prikazano na šemi ispod).

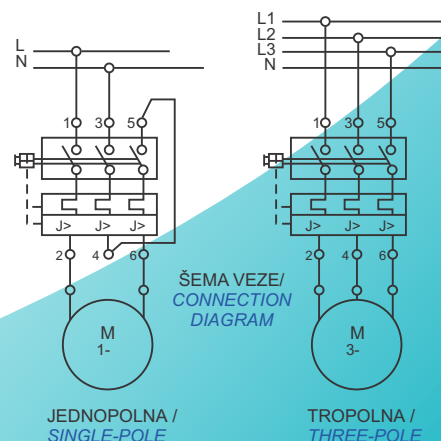

The manual motor starter is suitable for three phase applications-motors. Using connection diagram shown below you can connect single-phase applications.



MOTORNA ZAŠTITNA SKLOPKA 3VE-1



MANUAL MOTOR PROTECTOR/STARTER 3VE-1







Šifra Code	Opseg / Range	Pak. Pack.	Bar kod EAN code
23153	0,25A - 0,4A		 8 605009 1110594

Šifra Code	Opseg / Range	Pak. Pack.	Bar kod EAN code
23154	0,4A - 0,63A		 8 605009 1110600

Šifra Code	Opseg / Range	Pak. Pack.	Bar kod EAN code
5123	0,63A - 1A		 8 605009 1100175



Šifra Code	Opseg / Range	Pak. Pack.	Bar kod EAN code
4875	1A - 1,6A		 8 605009 1100182

Šifra Code	Opseg / Range	Pak. Pack.	Bar kod EAN code
4876	1,6A - 2,5A		 8 605009 1100199

Šifra Code	Opseg / Range	Pak. Pack.	Bar kod EAN code
4877	2,5A - 4A		 8 605009 1100205

MOTORNÁ ZAŠTITNÁ SKLOPKA 3VE-1

MANUAL MOTOR PROTECTOR/STARTER 3VE-1

Šifra Code	Opseg / Range	Pak. Pack.	Bar kod EAN code
4878	4A - 6A		 8 605009 1100212

Šifra Code	Opseg / Range	Pak. Pack.	Bar kod EAN code
4874	6A - 10A		 8 605009 1100229

Šifra Code	Opseg / Range	Pak. Pack.	Bar kod EAN code
4879	10A - 16A		 8 605009 1100236

Šifra Code	Opseg / Range	Pak. Pack.	Bar kod EAN code
5271	14A - 20A		 8 605009 1100243

Šifra Code	Opseg / Range	Pak. Pack.	Bar kod EAN code
4880	16A - 25A		 8 605009 1100250

ELEKTRIČNI KALORIFERI
I KUPATILSKE GREJALICE
*FAN HEATERS - CALORIFIERS
AND BATHROOM HEATERS*



ILI
OR



**** MOGUĆNOST IZRADE SA
INDUSTRIJSKIM UTIKAČEM
**THE POSSIBILITY OF MAKING IT WITH
INDUSTRIAL SOCKET (CEE NORM)**

NAMENA KALORIFERA

„MTG“ električni kaloriferi su najbolji izbor za brzo zagrevanje malih i srednjih prostorija, kao što su radionice, garaže, restorani. Značajno su zastupljeni u velikim prostorijama kao što su sportske hale, fabričke prostorije, magacinska skladišta, industrijski prostori. Regulisanje željene temperature vrši se preko regulacionog mehaničkog termostata. Kalorifer pruža trenutnu toplotu, potpuno suhu bez kondenzacije, bez gasa, bez dima i bez mirisa. Zagrevanje se vrši veoma brzo i ekonomično i u najhladnijim vremenskim prilikama, uz potpuno očuvanje ekološke sredine.

Tehničko rešenje i dizajn kalorifera omogućava pouzdan rad i dug vek trajanja. Za montažu kalorifera, preporučujemo zidni nosač namenski dizajniran i izrađen za tu svrhu.

PURPOSE OF THE CALORIFIER

“MTG” Electrical fan heaters (calorifiers) are a best choice for quickly heating small, medium-sized rooms, such as workshops, garages, restaurants, and also have their used in large rooms such as sport halls, factory rooms, warehouses. The regulation of the desired temperature is controlled via the regulating mechanical thermostat. Delivering an instant heat which is totally dry with no condensation, no gas, no fumes and no odours. Heating works very quickly and economically even in the coldest weather conditions, with full protection of ecological environment.

Technical solution and design of fan heater (calorifier) provides reliable operation and long lifetime. We recommend our product holder that is designed specifically for that purpose.

Šifra Code	Dimenzije Dimensions	Zagreva prostor Heating area		Protok vazduha Air flow	Težina Weight	Pak. Pack.	Bar kod EAN code
	mm	mm ³	mm ²	m ³ /h	kg		
11632	240x280x375	60	25	600	10		8 605009 106641

snaga

3kW

power

napon

250V

voltage

opseg
reg. temp.

**5-30
C°**

temperature
range

snaga
motora

16W

motor
power

amperaža
osigurača

16A



fuse
amperage



ELEKTRIČNI KALORIFERI

FAN HEATERS - CALORIFIERS



Šifra Code	Dimenzije Dimensions mm	Zagreva prostor Heating area		Protok vazduha Air flow m ³ /h	Težina Weight kg	Pak. Pack.	Bar kod EAN code
		mm ³	mm ²				
11600	340x380x440	110	45	880	14		 8 605009 106658

snaga
6kW
power



napon
440V
voltage

opseg
reg. temp.
5-30
C°
temperature
range

snaga
motora
16W
motor
power

amperaža
osigurača
3x10A
fuse
amperage



Šifra Code	Dimenzije Dimensions mm	Zagreva prostor Heating area		Protok vazduha Air flow m ³ /h	Težina Weight kg	Pak. Pack.	Bar kod EAN code
		mm ³	mm ²				
11601	340x380x440	150	60	1250	14		 8 605009 106665

snaga
9kW
power



napon
440V
voltage

opseg
reg. temp.
5-30
C°
temperature
range

snaga
motora
25W
motor
power

amperaža
osigurača
3x16A
fuse
amperage



Šifra Code	Dimenzije Dimensions mm	Zagreva prostor Heating area		Protok vazduha Air flow m ³ /h	Težina Weight kg	Pak. Pack.	Bar kod EAN code
		mm ³	mm ²				
11602	340x380x440	200	75	1250	14		 8 605009 106672

snaga
12kW
power

napon
440V
voltage

opseg
reg. temp.
5-30
C°
temperature
range

snaga
motora
25W
motor
power

amperaža
osigurača
3x20A
fuse
amperage



Kalorifer sa modularnom sklopkom / Calorifier with modular switch

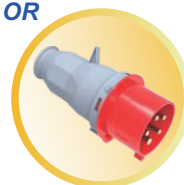

ILI
OR

**** MOGUĆNOST IZRADE SA
INDUSTRIJSKIM UTIKAČEM
**THE POSSIBILITY OF MAKING IT WITH
INDUSTRIAL SOCKET (CEE NORM)**

Šifra Code	Dimenzije	Zagreva prostor		Protok vazduha	Težina	Pak. Pack.	Bar kod EAN code
	Dimensions	Heating area		Air flow	Weight		
	mm	mm ³	mm ²	m ³ /h	kg		
11599	240x280x375	60	25	600	10		8 605009 106528

snaga

3kW

power

napon

250V

voltage

opseg
reg. temp.

**5-30
C°**

temperature
range

snaga
motora

16W

motor
power

amperaža
osigurača

16A

fuse
amperage



Šifra Code	Dimenzije	Zagreva prostor		Protok vazduha	Težina	Pak. Pack.	Bar kod EAN code
	Dimensions	Heating area		Air flow	Weight		
	mm	mm ³	mm ²	m ³ /h	kg		
11633	340x380x440	110	45	880	14		8 605009 106535

snaga

6kW

power

napon

440V

voltage

opseg
reg. temp.

**5-30
C°**

temperature
range

snaga
motora

16W

motor
power

amperaža
osigurača

3x10A



fuse
amperage



ELEKTRIČNI KALORIFERI



FAN HEATERS - CALORIFIERS



Šifra Code	Dimenzije Dimensions mm	Zagreva prostor Heating area		Protok vazduha Air flow m ³ /h	Težina Weight kg	Pak. Pack.	Bar kod EAN code
		mm ³	mm ²				
11634	340x380x440	150	60	1250	14		 8 605009 1106542 1



snaga 9kW power	napon 440V voltage	opseg reg. temp. 5-30 C° temperature range	snaga motora 25W motor power	amperaža osigurača 3x16A fuse amperage
------------------------------	---------------------------------	--	---	---



Šifra Code	Dimenzije Dimensions mm	Zagreva prostor Heating area		Protok vazduha Air flow m ³ /h	Težina Weight kg	Pak. Pack.	Bar kod EAN code
		mm ³	mm ²				
11635	340x380x440	200	75	1250	14		 8 605009 1106559 1

snaga 12kW power	napon 440V voltage	opseg reg. temp. 5-30 C° temperature range	snaga motora 25W motor power	amperaža osigurača 3x20A fuse amperage
-------------------------------	---------------------------------	--	---	---



Šifra Code	Dimenzije Dimensions mm	Zagreva prostor Heating area		Protok vazduha Air flow m ³ /h	Težina Weight kg	Pak. Pack.	Bar kod EAN code
		mm ³	mm ²				
13784	340x380x515	250	100	1400	15		 8 605009 1107105 1

snaga 15kW power	napon 440V voltage	opseg reg. temp. 5-30 C° temperature range	snaga motora 34W motor power	amperaža osigurača 3x25A fuse amperage
-------------------------------	---------------------------------	--	---	---



NOSAČ KALORIFERA / CALORIFER HOLDER

Šifra Code	Artikal / Article	Pak. Pack.	Bar kod EAN code
9365	NOSAČ KALORIFERA / CALORIFER HOLDER		 8 605009 1102605 1

NAMENA GREJALICE

„MTG“ grejalica za kupatilo je električni reflektujući grejač prostora koji se koristi u domaćinstvima za zagrevanje kupatila a, ako je potrebno, može se koristiti i u svim ostalim prostorima kućnog okruženja. Grejanje se vrši statičkim prenosom toplotne energije preko električnih infra grejača, usmerenih prema primarnoj zoni (mestu, području) grejnog prostora. Grejalica za kupatilo se montira na zid a uključuje se preko indikatora zidnog prekidača.

Proizvod je izrađen od visoko kvalitetnih materijala, prohroma i drugih metalnih legura koji garantuju visok kvalitet samog proizvoda.

PURPOSE OF THE HEATER

“MTG” Bathroom heater is an electric reflector heater are used in households to warm the bathroom and, if necessary, in the other spaces of house environment. The heating is done by static heat transfer of the tube electric infra heaters, which is directed by on primary zone (area, place) to warming space. The bathroom heater is mounting on the wall, and is switched on by a switch wall indicator.

It is made of quality materials that guarantee high quality product.



Šifra Code	Model Model	Pak. Pack.	Bar kod EAN code
12463	1200W		 8 1605009 106634
11665	2000W		 8 1605009 106689



Šifra Code	Model Model	Pak. Pack.	Bar kod EAN code
11666	1200W+800W sa poteznim prekidačem		 8 1605009 106696



Uslužno konfekcioniranje savitljivih kablova je novija delatnost **MAK TRADE GROUP**. Tehničko znanje, iskustvo u radu sa kablovima, kao i odgovarajući alati, omogućavaju nam brzo i kvalitetno ulivanje nerastavnih utikača i priključnica. U procesu izrade omotača utikača i priključnica koriste se kvalitetni PVC granulati poznatih proizvođača.

*Service confectioning of flexible cables is a newer activity of **MAK TRADE GROUP**. Technical knowledge, experience in working with cables, as well as suitable tools, enable us to insert non-rewireable plugs and sockets quickly and in quality manner. Quality PVC granulates of the renowned manufacturers are used in the process of manufacturing the sheath of plugs and sockets.*

Nerastavni dvopolni utikač
Unwireable two-pole angled plug
 2P+E, 16A, 250V



MTG-403

H05VV-F	H05RR-F
3x0,75	3x1,00
3x1,00	3x1,50
3x1,50	3x2,50
3x2,50	

Nerastavni dvopolni utikač
Unwireable two-pole straight plug
 2P, 16A, 250V



MTG-402

H05VV-F	H05RR-F
2x0,75	2x1,00
2x1,00	2x1,50
2x1,50	

Nerastavni dvopolni utikač
Unwireable two-pole straight plug
 2P, 2,5A, 250V EURO



H03VV-F
 2x0,75

Nerastavni trolepolni utikač
Unwireable three-pole angled plug
 3P+E+N, 16A, 440V



MTG-3P

H05VV-F	H05RR-F
5x2,50	5x2,50

Nerastavni dvopolna priključnica
Unwireable two-pole straight socket
 2P+E, 16A, 250V



MTG-703

H05VV-F	H05RR-F
3x0,75	3x1,00
3x1,00	3x1,50
3x1,50	3x2,50
3x2,50	

Nerastavni dvopolna priključnica
Unwireable two-pole straight socket
 2P, 16A, 250V



MTG-701B

H05VV-F	H05RR-F
2x0,75	2x1,00
2x1,00	2x1,50
2x1,50	

KABLOVSKI SETOVI / CABLE SETS

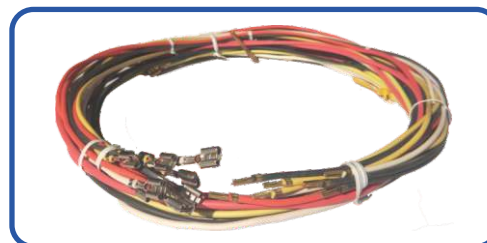

Izrada setova provodnika po specifikaciji klijenta
Manufacturing of conductor sets according to client's specification